

### BLOWER & A/C CONTROLS

E2FEFBC7

## BLOWER & A/C CONTROLS (AUTO) (1)

SD971-1

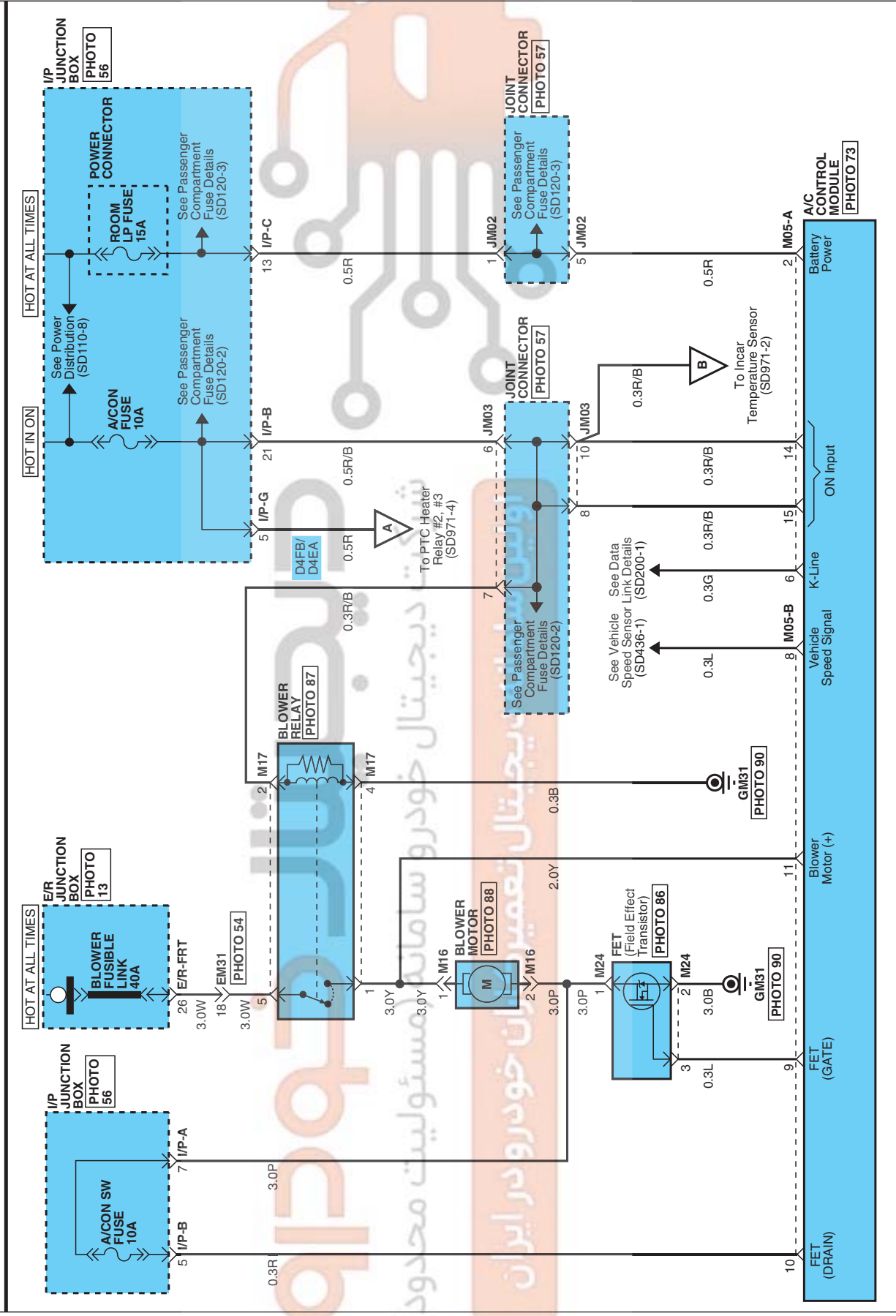

E2FEFBC7

BLOWER & A/C CONTROLS

BLOWER & A/C CONTROLS (AUTO) (2)

SD971-2

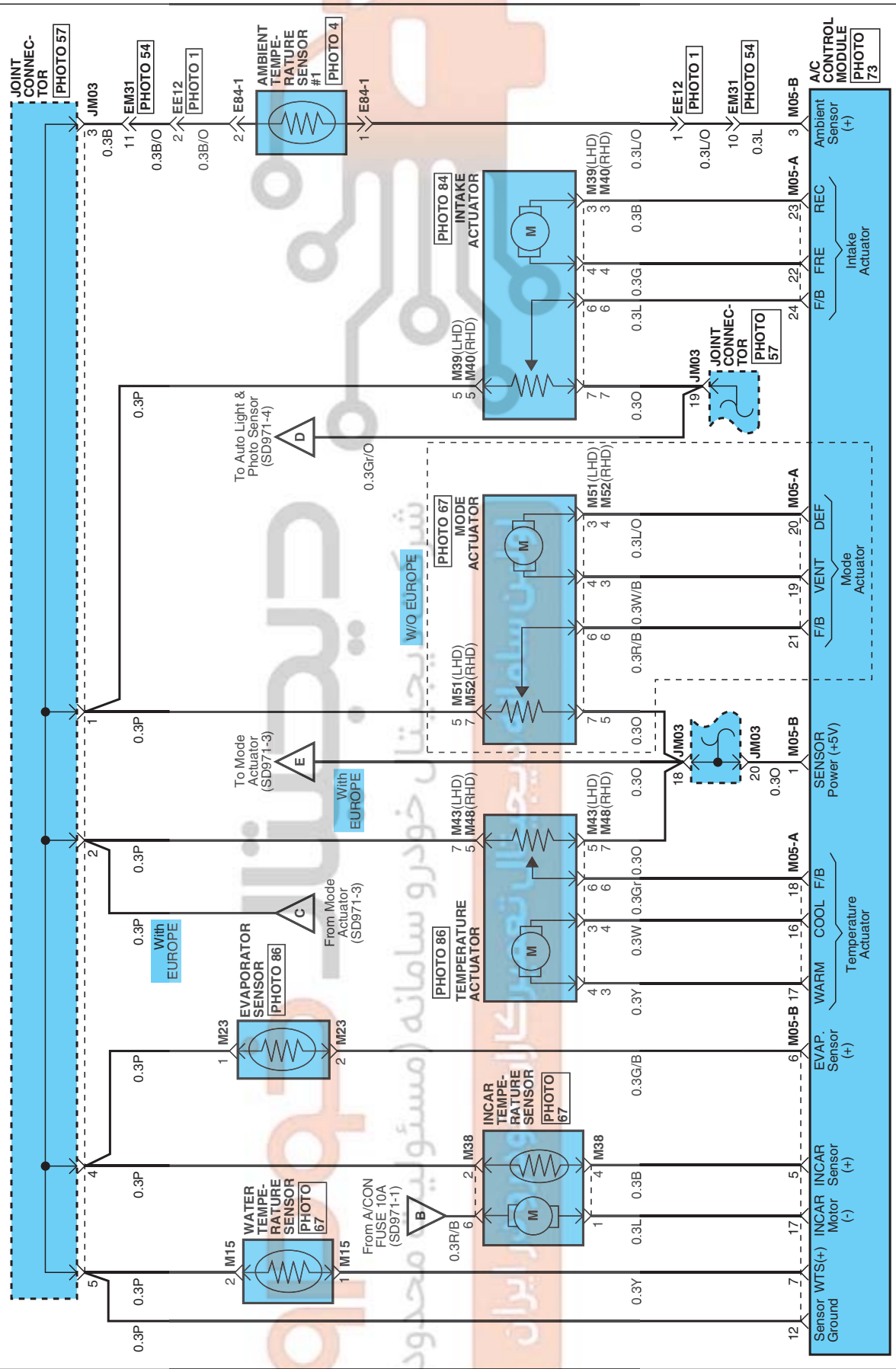

EFDSD8971BL

BLOWER & A/C CONTROLS

BLOWER & A/C CONTROLS (AUTO) (3)

SD971-3

With EUROPE

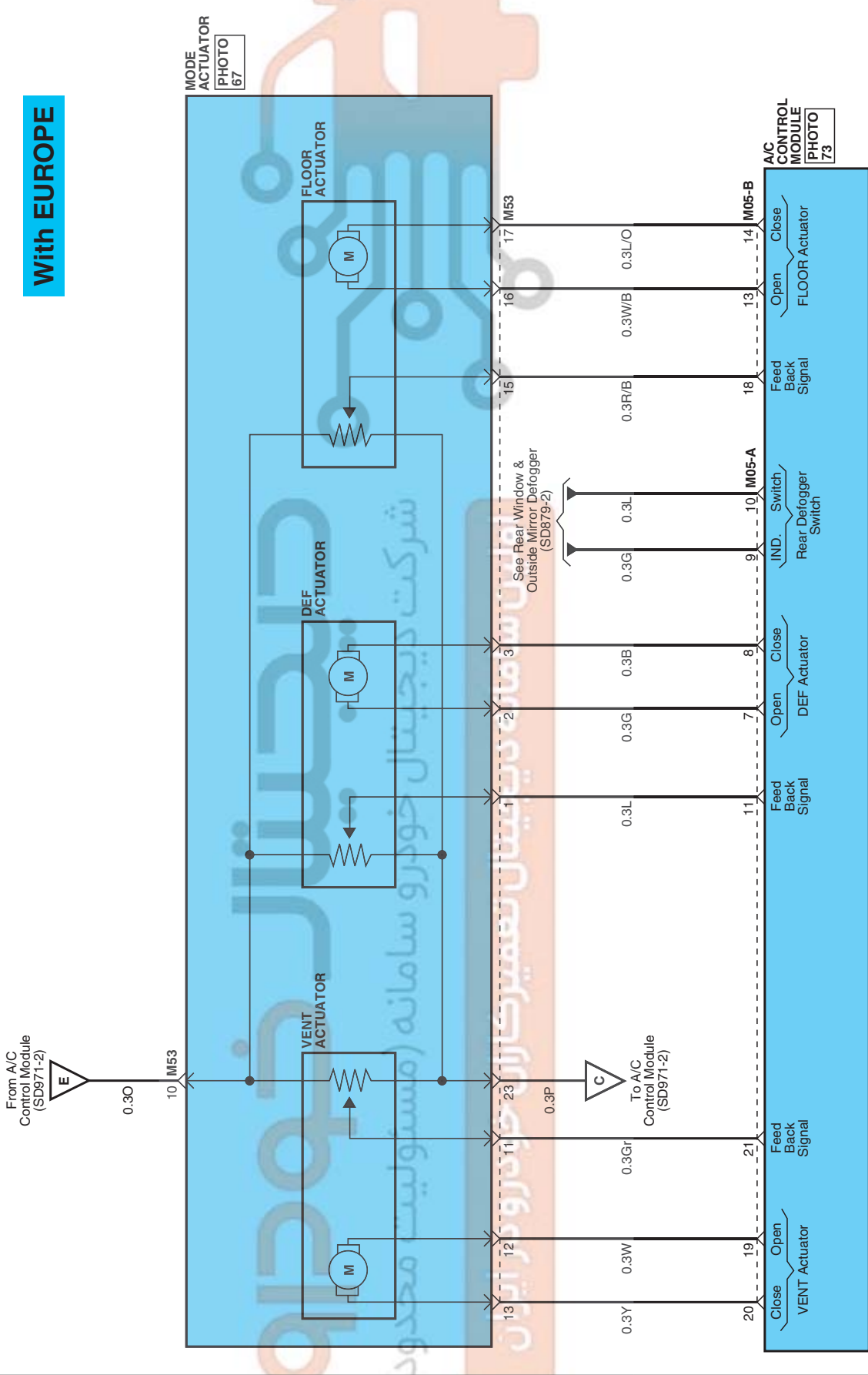

### BLOWER & A/C CONTROLS (AUTO) (4)

SD971-4

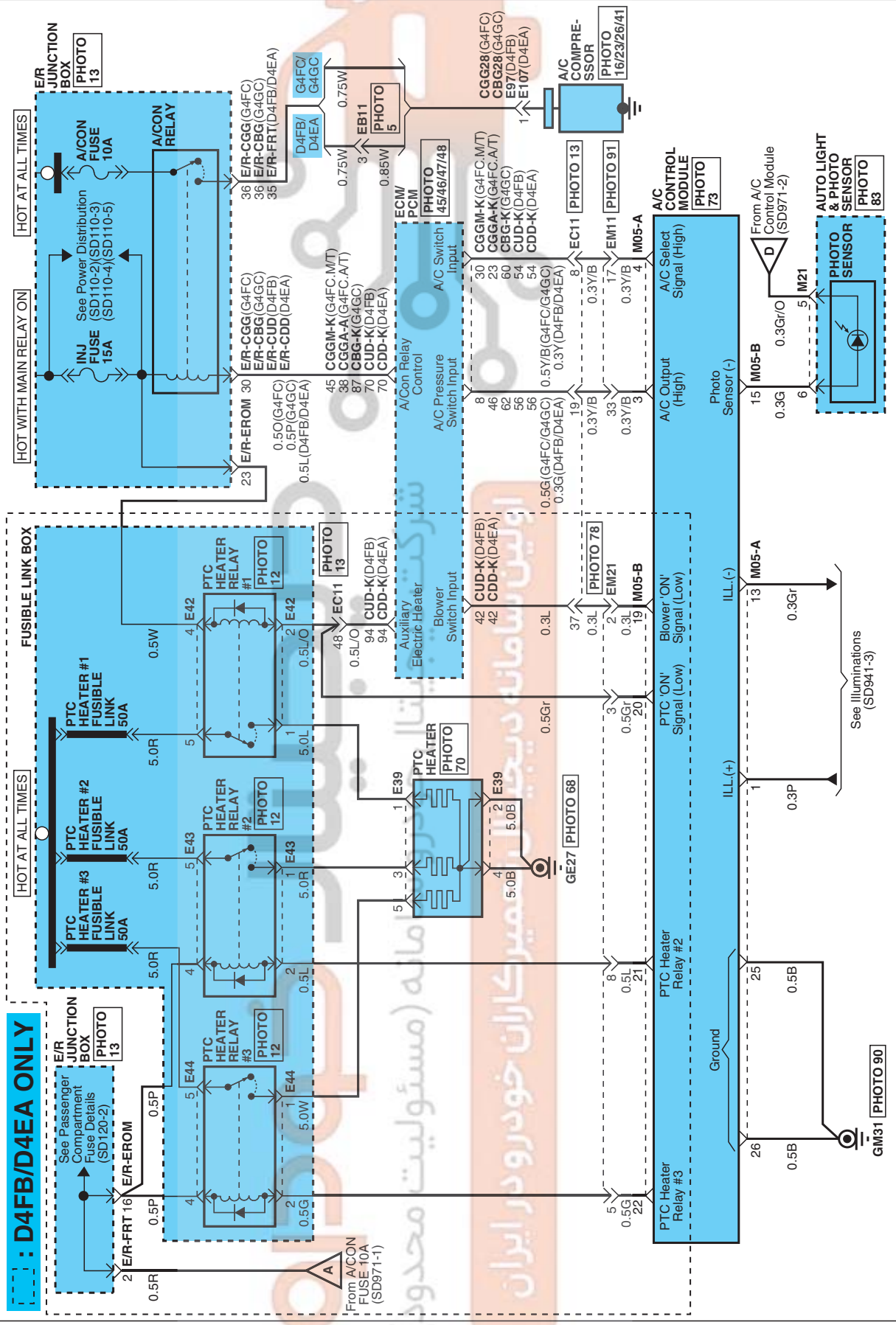

EFDS0897IDL

**BLOWER & A/C CONTROLS**





**BLOWER & A/C CONTROLS (AUTO) (5)**

<p><b>CGGA-A</b></p> <p>AMP_ECU_60F_B</p>	<p><b>SD971-5</b></p> <p><b>CGGA-K</b></p> <p>AMP_ECU_94F_B</p>
<p><b>CGGM-K</b></p> <p>AMP_ECU_94F_B</p>	<p><b>CBG-K</b></p> <p>AMP_ECU_94F_B</p>
<p><b>CUD-K</b></p> <p>AMP_ECU_94F_B</p>	<p><b>CDD-K</b></p> <p>AMP_ECU_94F_B</p>
<p><b>CGG28</b></p> <p>KUM_NMWMP_01F_B</p>	<p><b>E39</b></p> <p>AMP_PTC_05F_B</p>
<p><b>E43</b></p> <p>KUM_NMWMP_01F_B</p>	<p><b>E42</b></p> <p>AMP_PTC_05F_B</p>
<p><b>E44</b></p> <p>KUM_NMWMP_01F_B</p>	<p><b>E97</b></p> <p>KUM_NMWMP_01F_B</p>

**BLOWER & A/C CONTROLS**

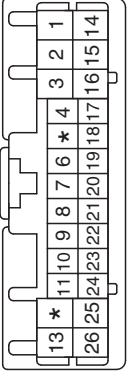
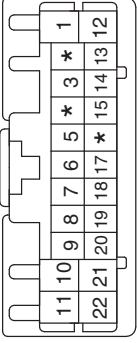
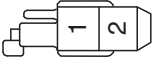
**BLOWER & A/C CONTROLS (AUTO) (6)**

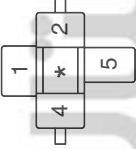
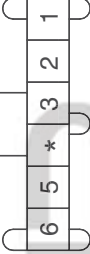
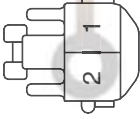
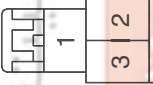
**SD971-6**

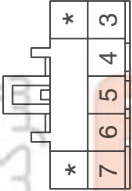
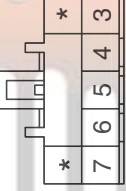
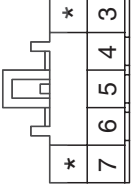
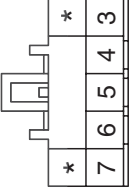
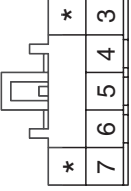
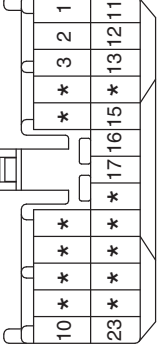
<p><b>E107</b></p>  <p>KUM_NMWP_01F_B</p>	<p><b>M05-A</b></p>  <p>KET_0407_26F_W</p>	<p><b>M05-B</b></p>  <p>KET_0407_22F_W</p>	<p><b>M15</b></p>  <p>KET_0901L_02F_W_SPK</p>				
<p><b>M16</b></p>  <p>KUM_DSD_02F_W</p>	<p><b>M17</b></p>  <p>KET_250_05F_W_RLY</p>	<p><b>M21</b></p>  <p>KET_91A_06F_W</p>	<p><b>M23</b></p>  <p>KET_0901L_02F_W_L</p>				
<p><b>M24</b></p>  <p>KUM_DSD_03F_B</p>	<p><b>M38</b></p>  <p>KET_91A_06F_W</p>	<p><b>M39</b></p>  <p>KUM_CDR_07F_L</p>	<p><b>M40</b></p>  <p>KUM_CDR_07F_L</p>				
<p><b>M43</b></p>  <p>KUM_CDR_07F_W</p>	<p><b>M51</b></p>  <p>KUM_CDR_07F_L</p>	<p><b>M52</b></p>  <p>KUM_CDR_07F_L</p>	<p><b>M53</b></p>  <p>KET_050_23F_W</p>				
<p><b>BLANK</b></p>		<p><b>BLANK</b></p>		<p><b>BLANK</b></p>		<p><b>BLANK</b></p>	