

BLOWER & A/C CONTROLS EDBCC7F

BLOWER & A/C CONTROLS (AUTO) (1)

SD971-1

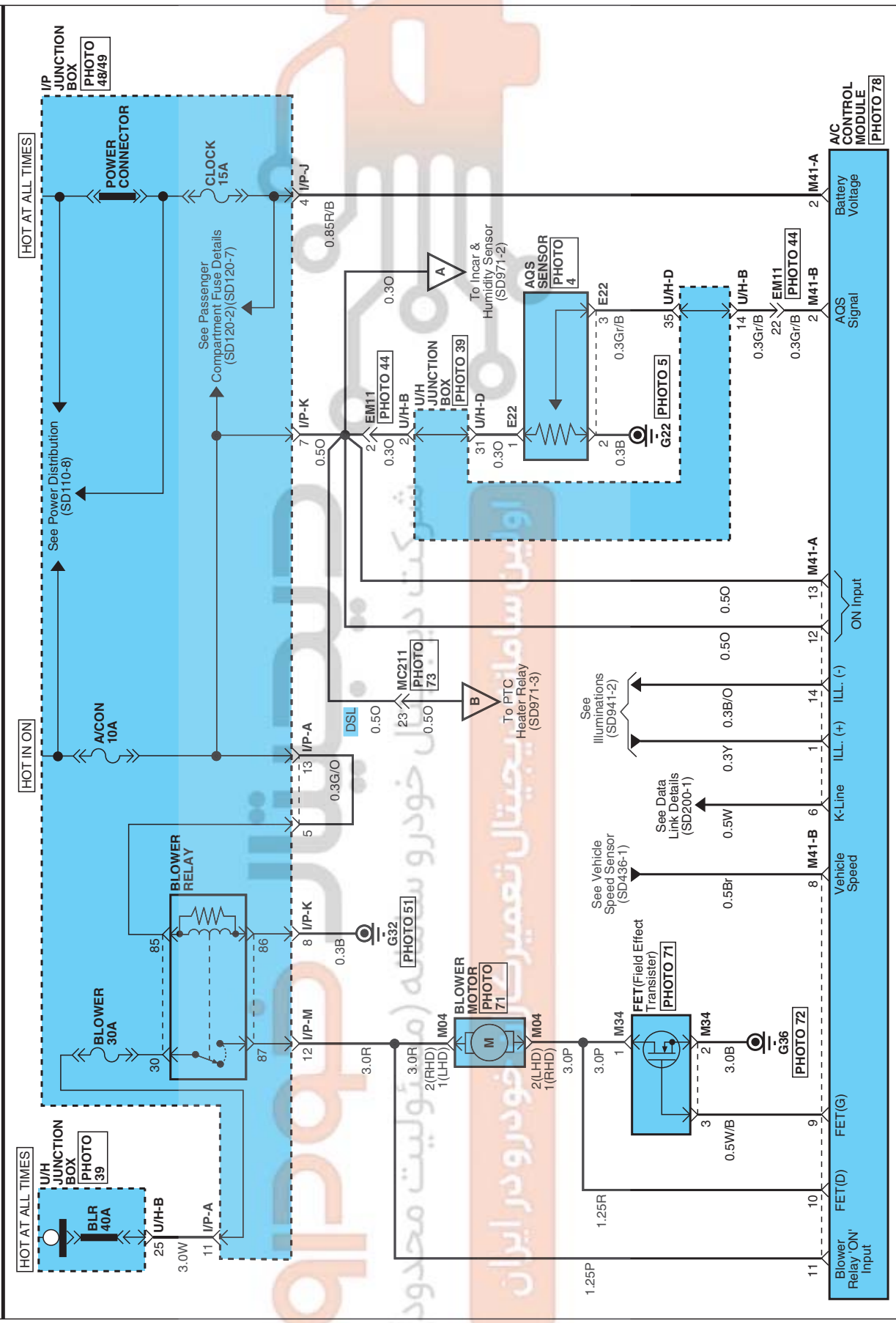

BLOWER & A/C CONTROLS BLOWER & A/C CONTROLS (AUTO) (2)

SD971-2

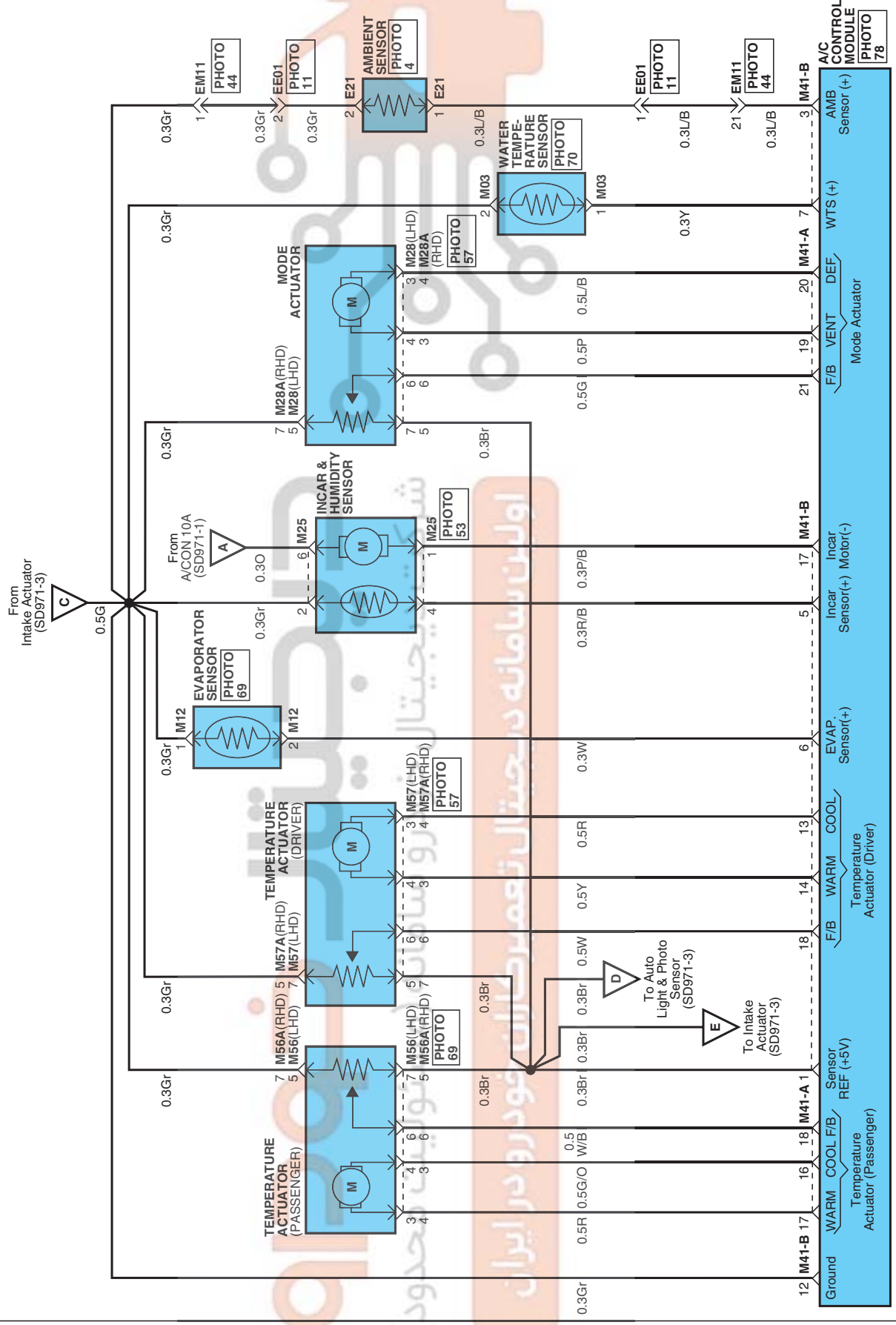

BLOWER & A/C CONTROLS

BLOWER & A/C CONTROLS (AUTO) (3)

SD971-3

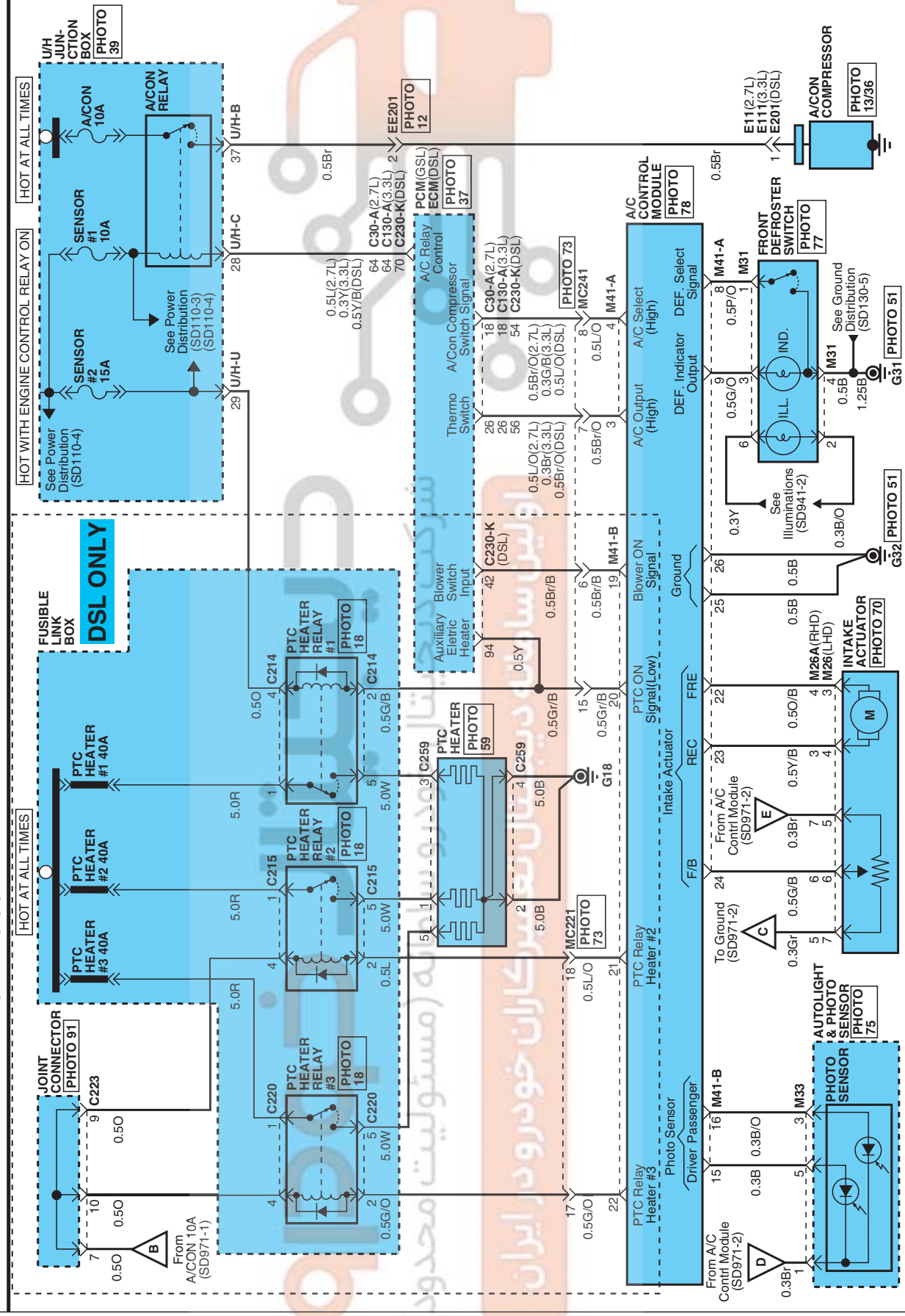

BLOWER & A/C CONTROLS

BLOWER & A/C CONTROLS (AUTO) (4)

C30-A		C130-A		SD971-4	
<p>PKD_ECU_80F_Gr_NR</p>	<p>PKD_ECU_80F_Gr_3</p>	<p>C214</p> <p>CR05F031</p>	<p>C220</p> <p>CR05F031</p>	<p>C259</p> <p>AMP_375_05F_B</p>	<p>E21</p> <p>KET_SWP_02F_B</p>
<p>C230-K</p> <p>AMP_ECU_94F_B</p>	<p>C215</p> <p>CR05F031</p>	<p>E11</p> <p>PB625_01027</p>	<p>E201</p> <p>PB625_01027</p>	<p>M03</p> <p>KET_090IIL_02F_B_SPK</p>	<p>E22</p> <p>KET_SWP_03F_B</p>
<p>E111</p> <p>PB625_01027</p>	<p>E11</p> <p>PB625_01027</p>	<p>E201</p> <p>PB625_01027</p>	<p>E201</p> <p>PB625_01027</p>	<p>E201</p> <p>PB625_01027</p>	<p>E201</p> <p>PB625_01027</p>

BLOWER & A/C CONTROLS

BLOWER & A/C CONTROLS (AUTO) (5)

SD971-5

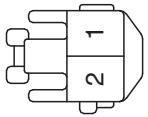
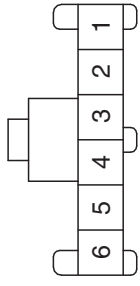
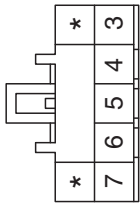
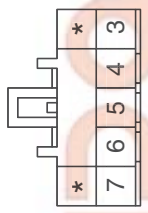
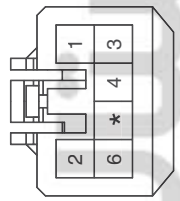
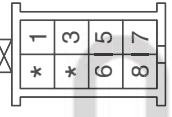
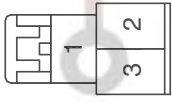
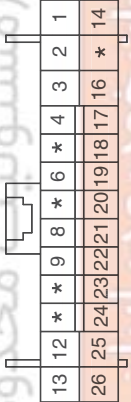
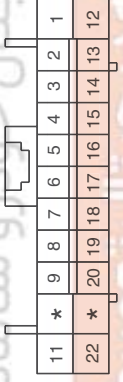
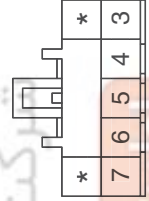
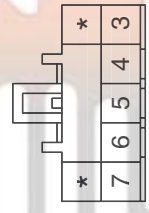
<p>M04</p>  <p>KET_250_02F_W</p>	<p>M12</p>  <p>KET_090II_02F_W_L</p>	<p>M25</p>  <p>KET_91A_08F_W</p>	<p>M26/M26A</p>  <p>KUM_CDR_07F_B</p>
<p>M28/M28A</p>  <p>KUM_CDR_07F_W</p>	<p>M31</p>  <p>AMP_090III_06F_L</p>	<p>M33</p>  <p>KET_090_08F_Br</p>	<p>M34</p>  <p>KUM_DSD_03F_B</p>
<p>M41-A</p>  <p>AMP_0407_26F_W_HD</p>	<p>M41-B</p>  <p>AMP_0407_22F_W</p>	<p>M56/M56A</p>  <p>KUM_CDR_07F_W</p>	<p>M57/M57A</p>  <p>KUM_CDR_07F_B</p>

BLOWER & A/C CONTROLS

BLOWER & A/C CONTROLS (AUTO) (6)

SD971-6

MEMO

دیجیتال خودرو

شرکت دیجیتال خودرو سامانه (مسئولیت محدود)

اولین سامانه دیجیتال تعمیرکاران خودرو در ایران

