

- * 1 : A/T
- * 2 : M/T
- * 3 : w/ Entry & Start System
- * 7 : w/o Entry & Start System

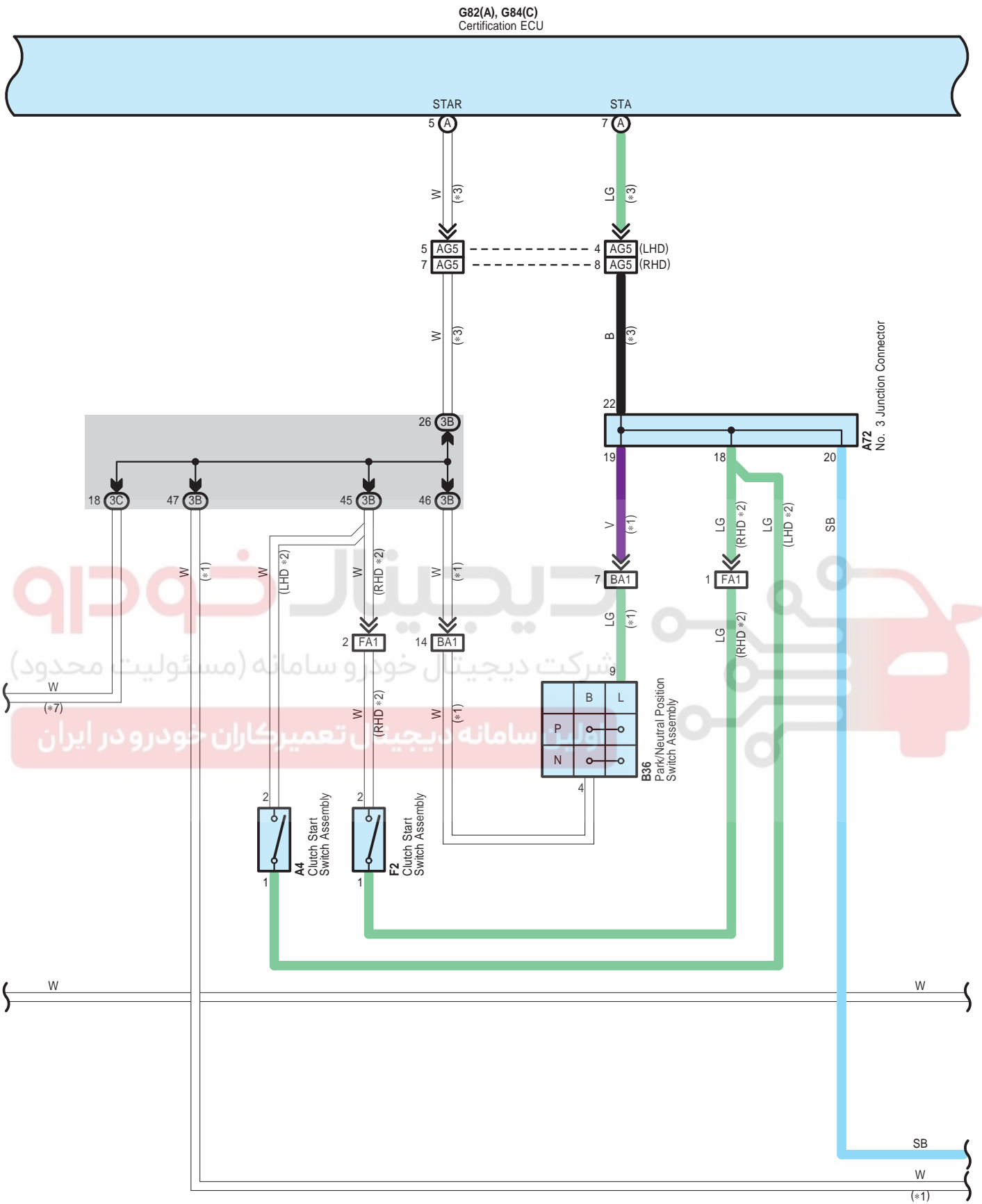

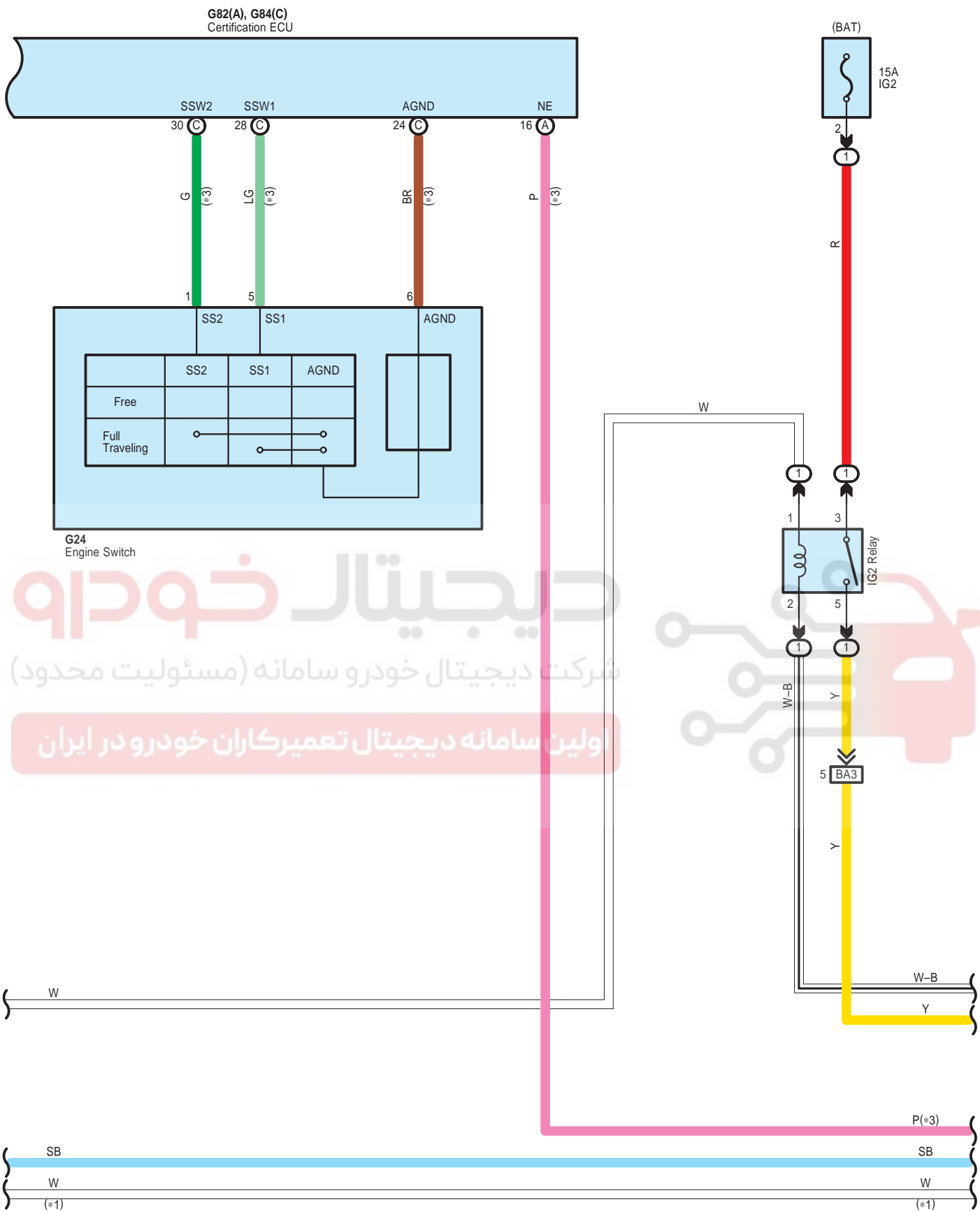

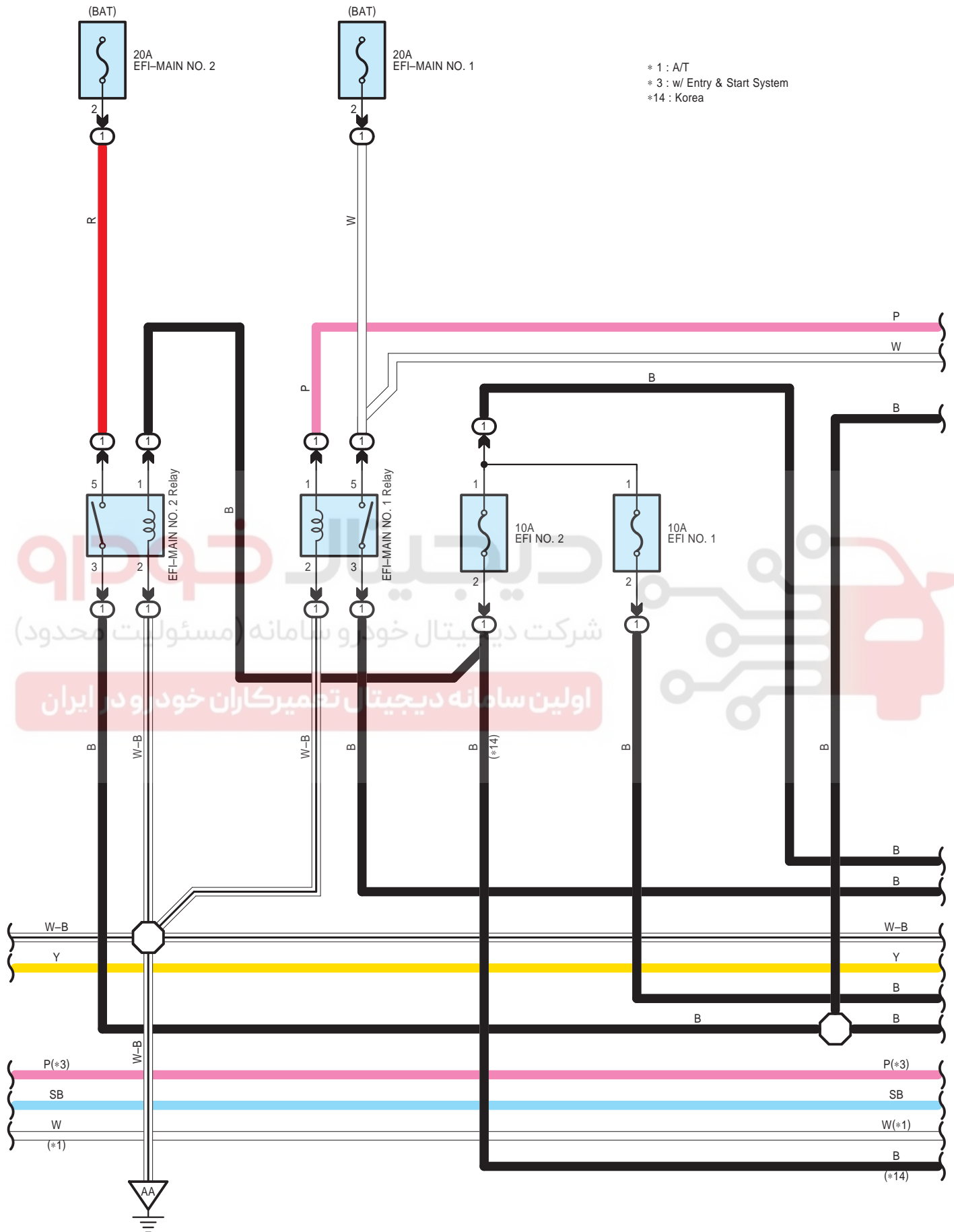

Cruise Control (2AR-FE) (Before Oct. 2015 Production), ECT and A/T Indicator (2AR-FE) (Before Oct. 2015 Production), Engine Control (2AR-FE) (Before Oct. 2015 Production)

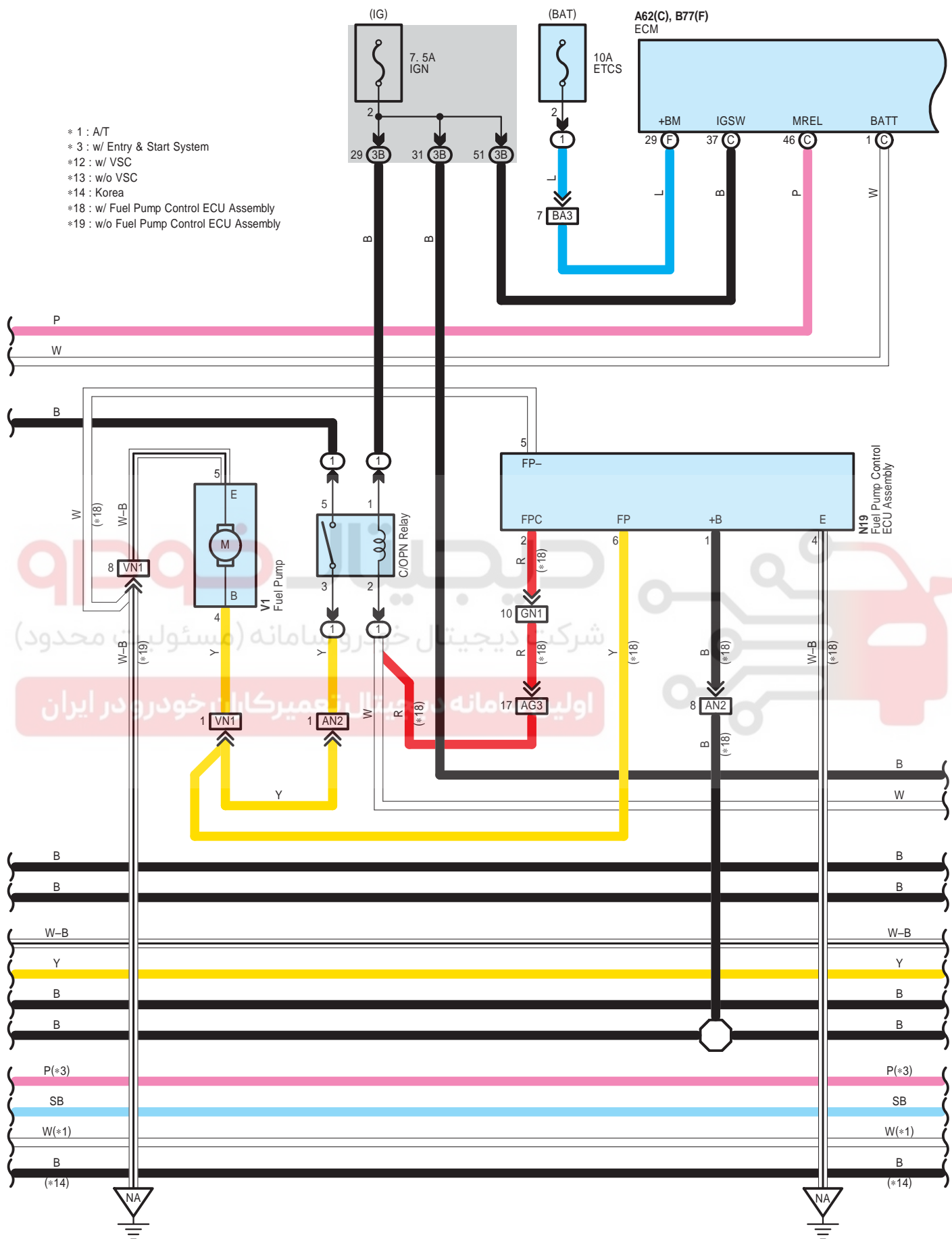

A62(C), B77(F)
ECM

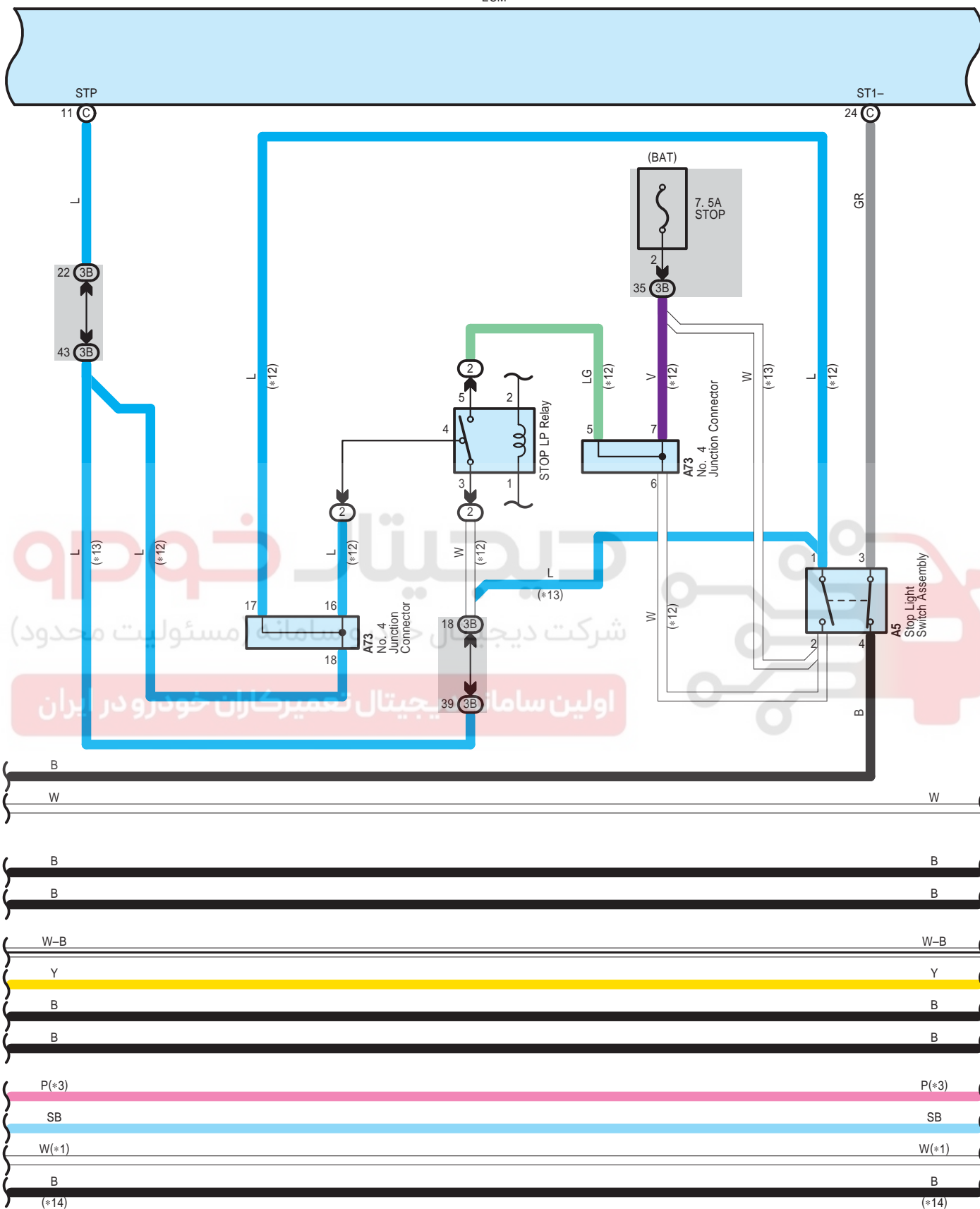

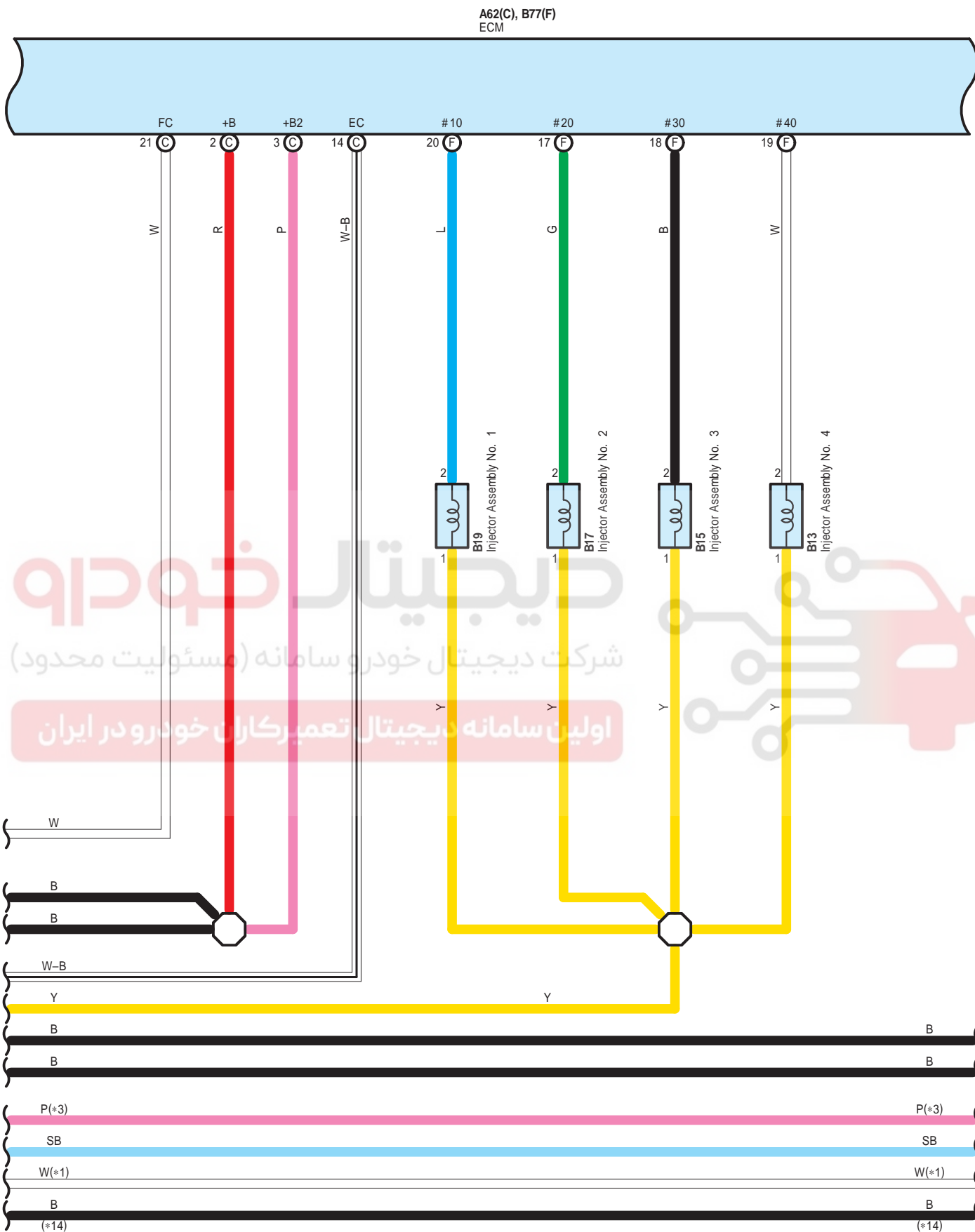

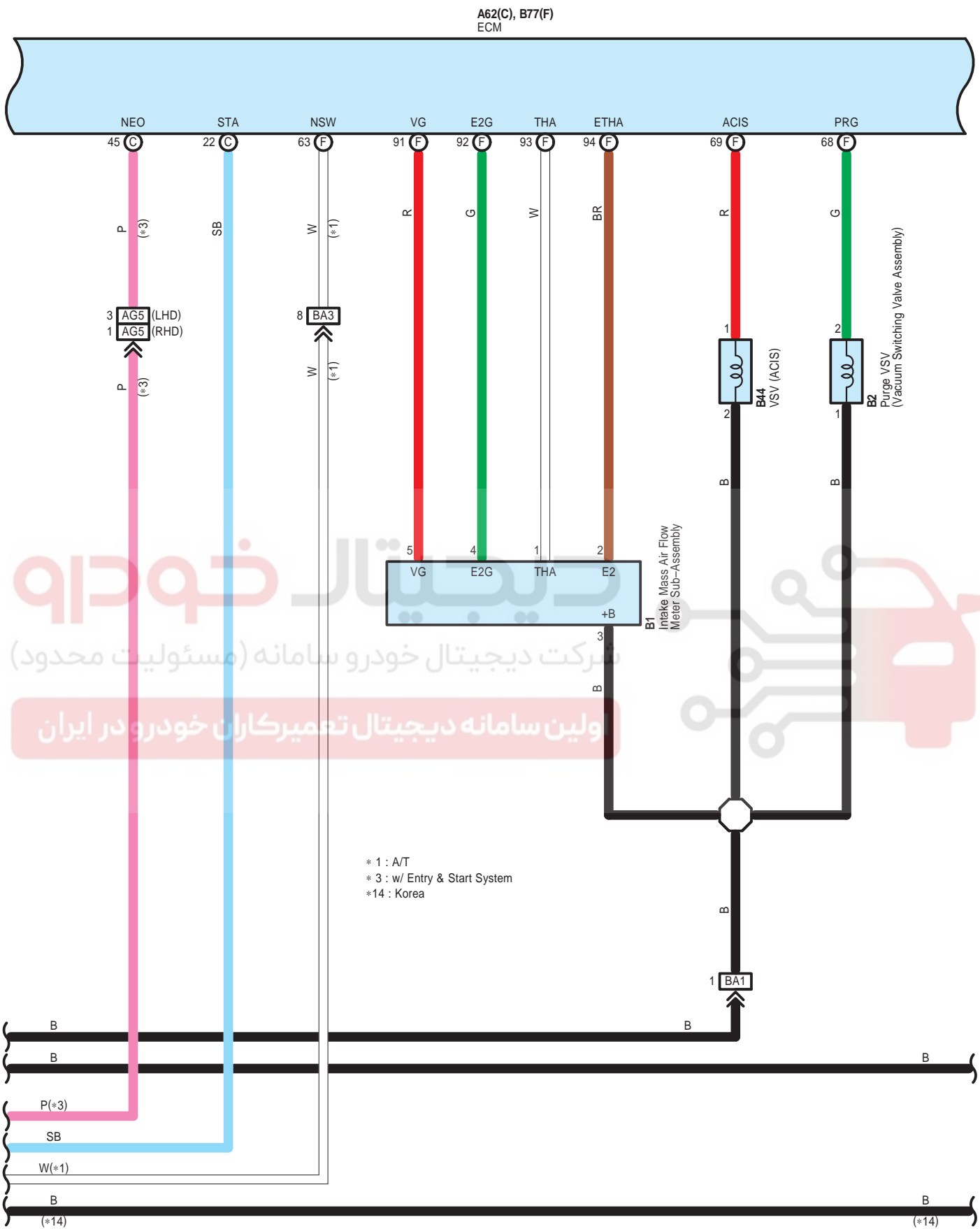

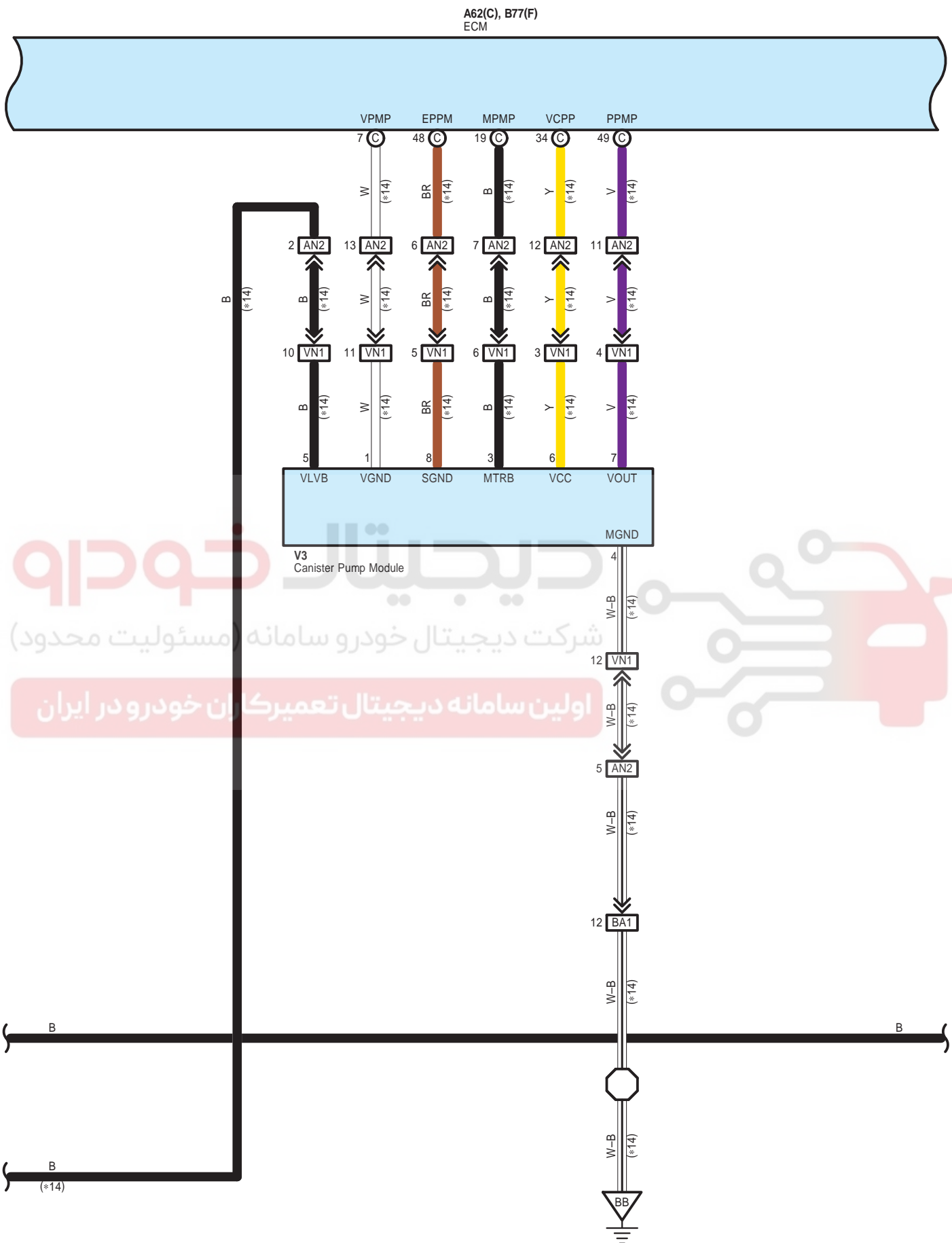

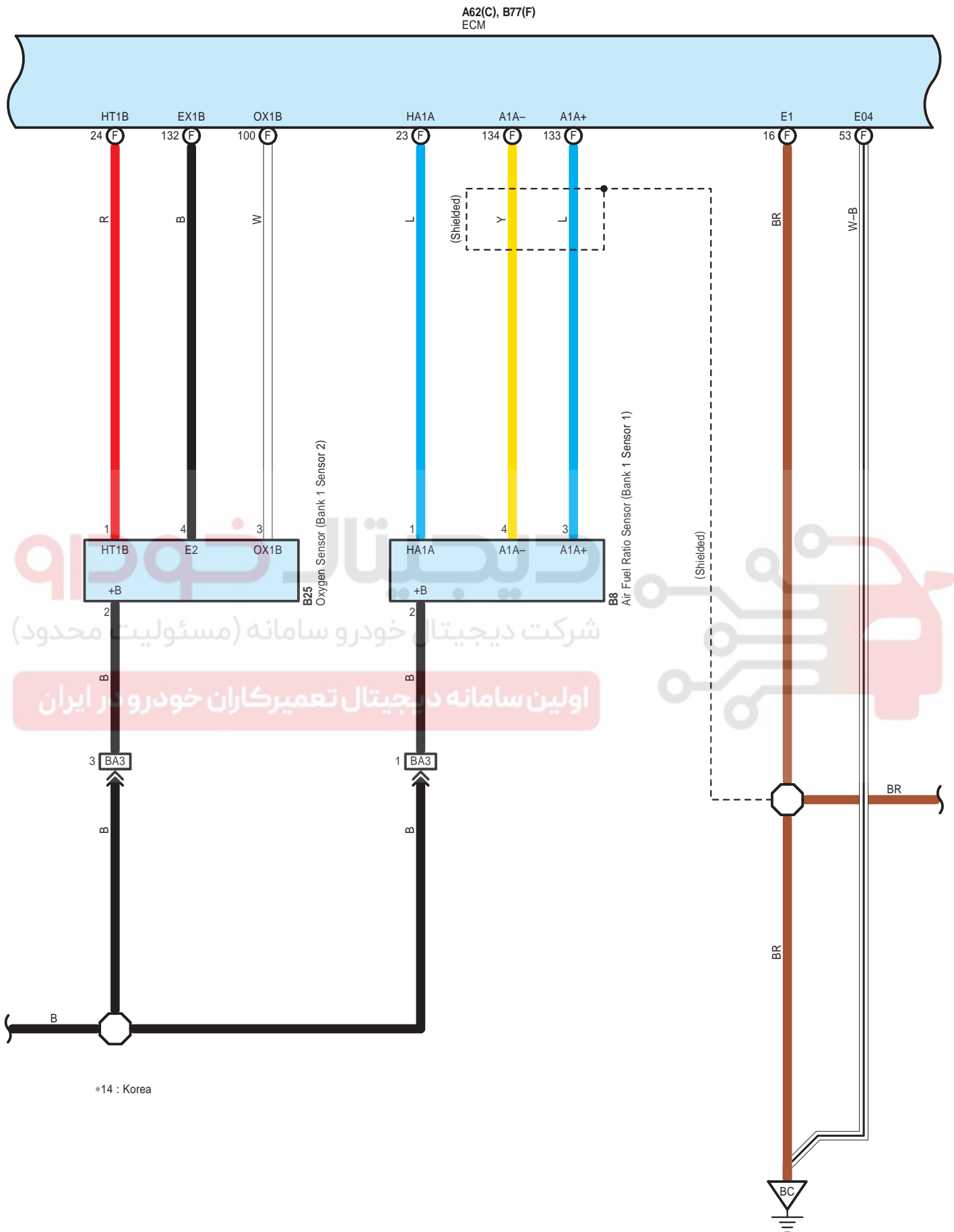

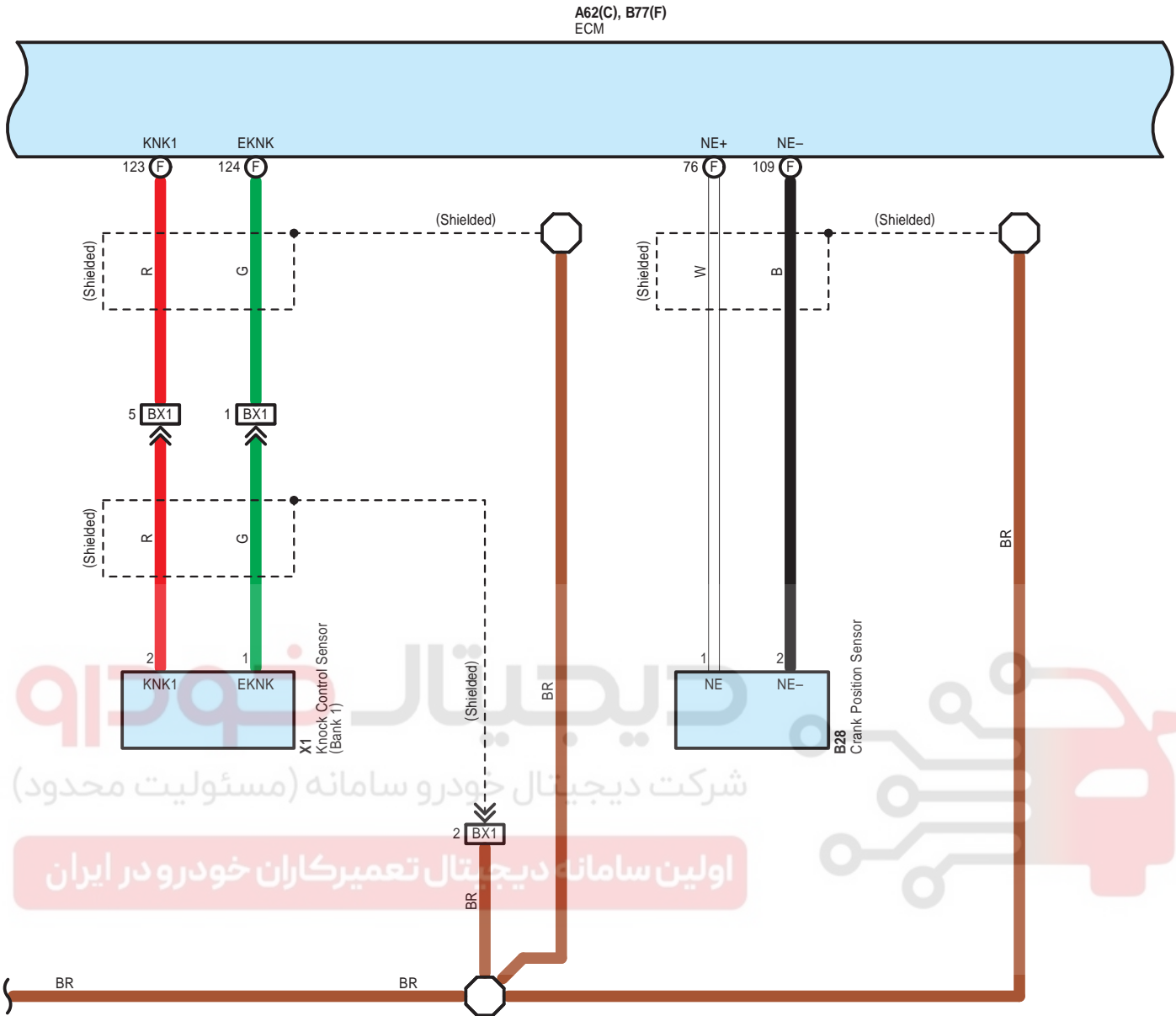

دیجیتال خودرو
شرکت دیجیتال خودرو سامانه (مسئولیت محدود)
اولین سامانه دیجیتال تعمیرکاران خودرو در ایران

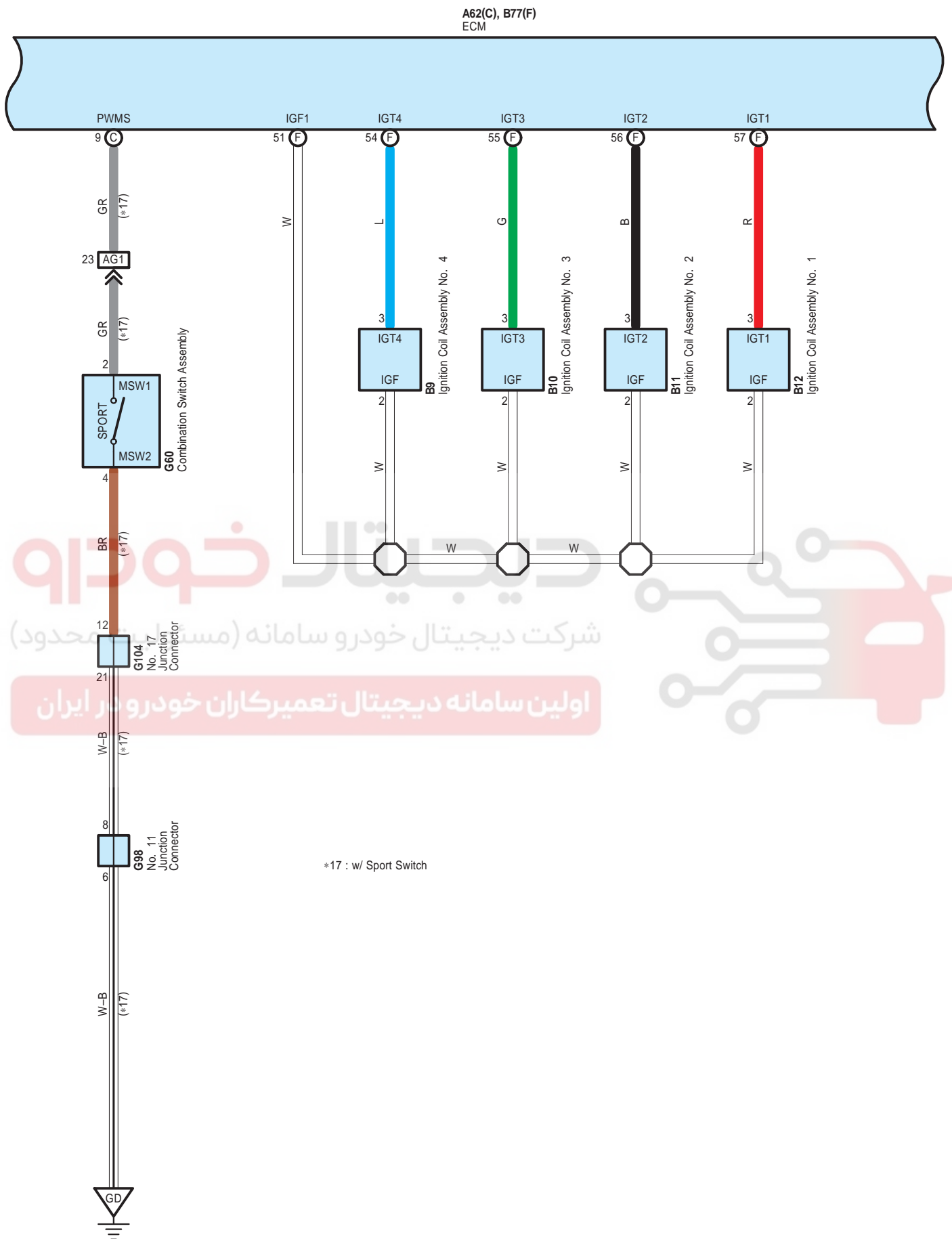

دیجیتال خودرو
شرکت دیجیتال خودرو سامانه (مسئله محدود)
اولین سامانه دیجیتال تعمیرکاران خودرو در ایران

*17 : w/ Sport Switch

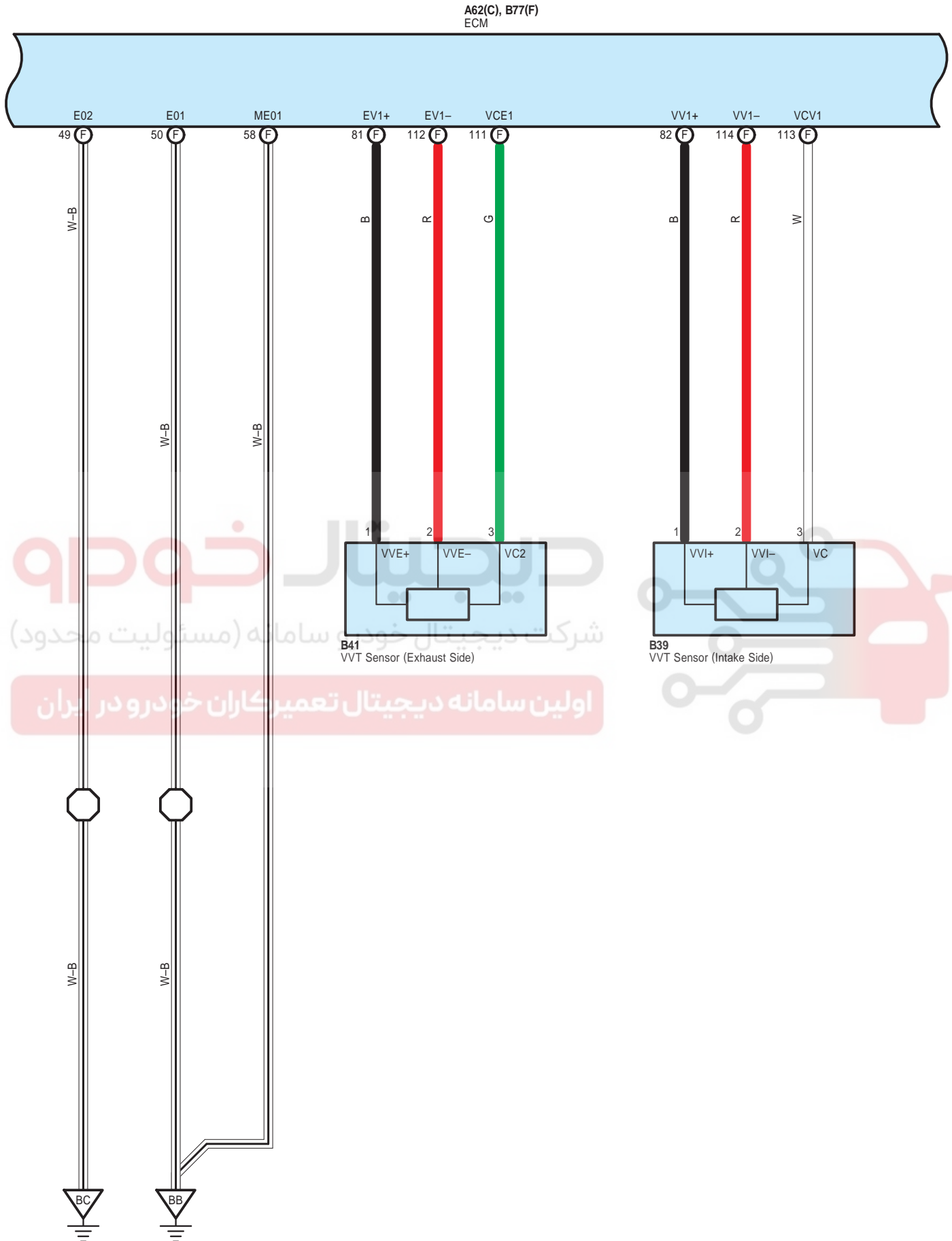

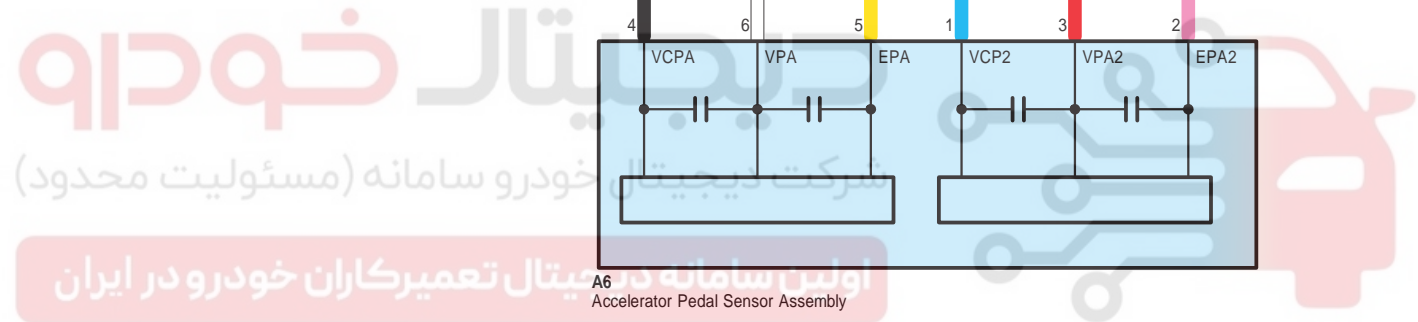
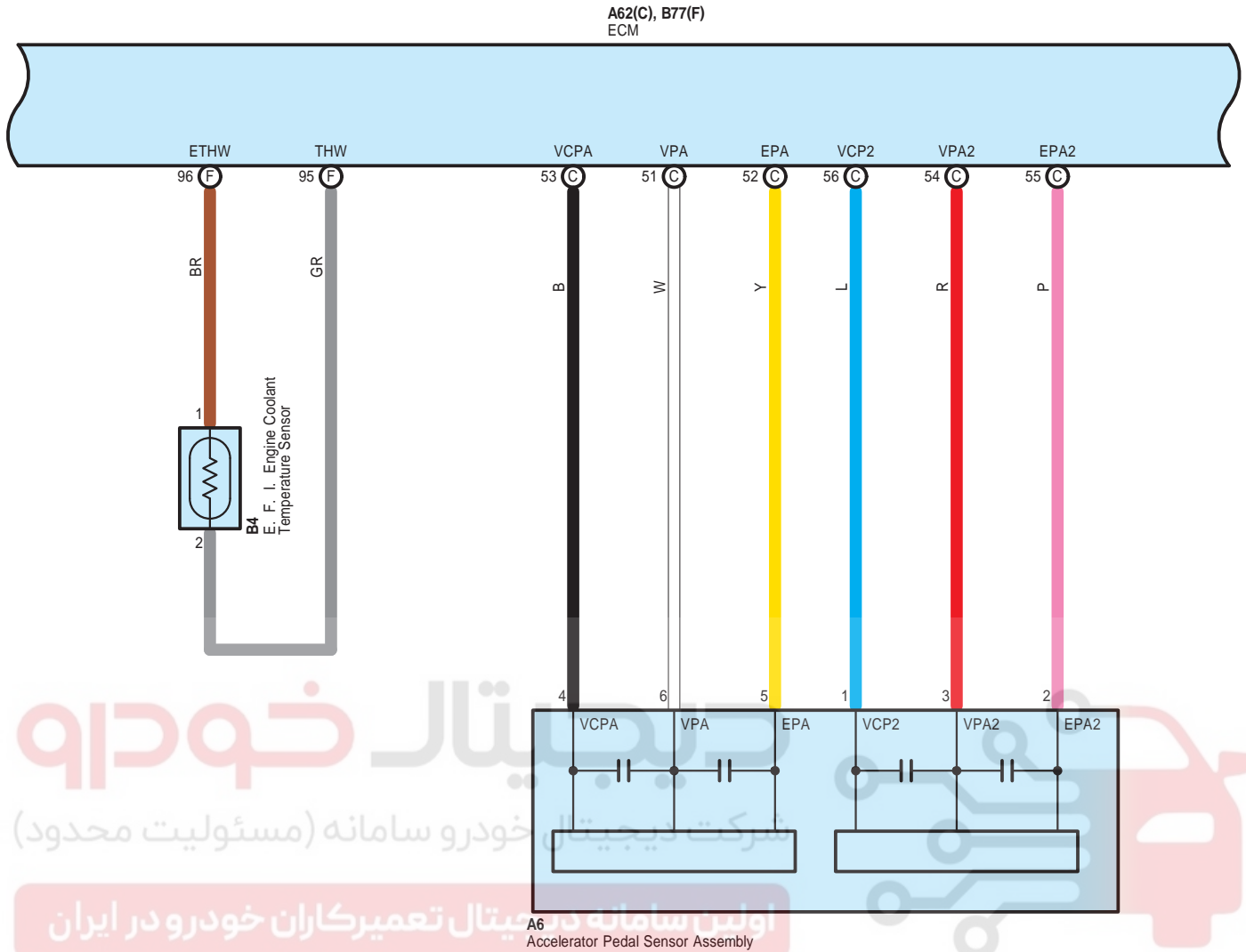

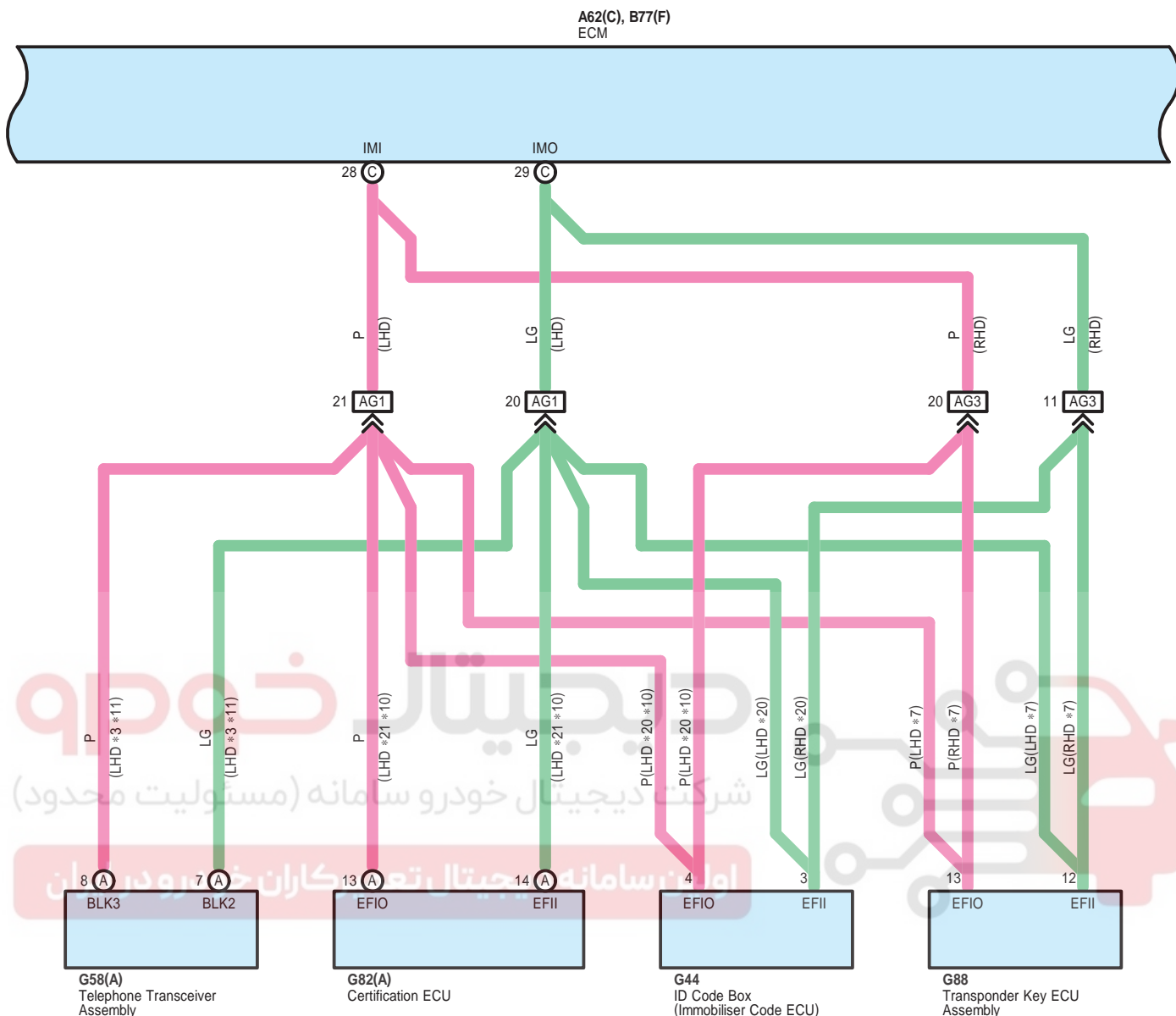

- * 3 : w/ Entry & Start System
- * 7 : w/o Entry & Start System
- *10 : w/o Blocking System
- *11 : w/ Blocking System
- *20 : w/ Entry & Start System w/ ID Code Box
- *21 : w/ Entry & Start System w/o ID Code Box

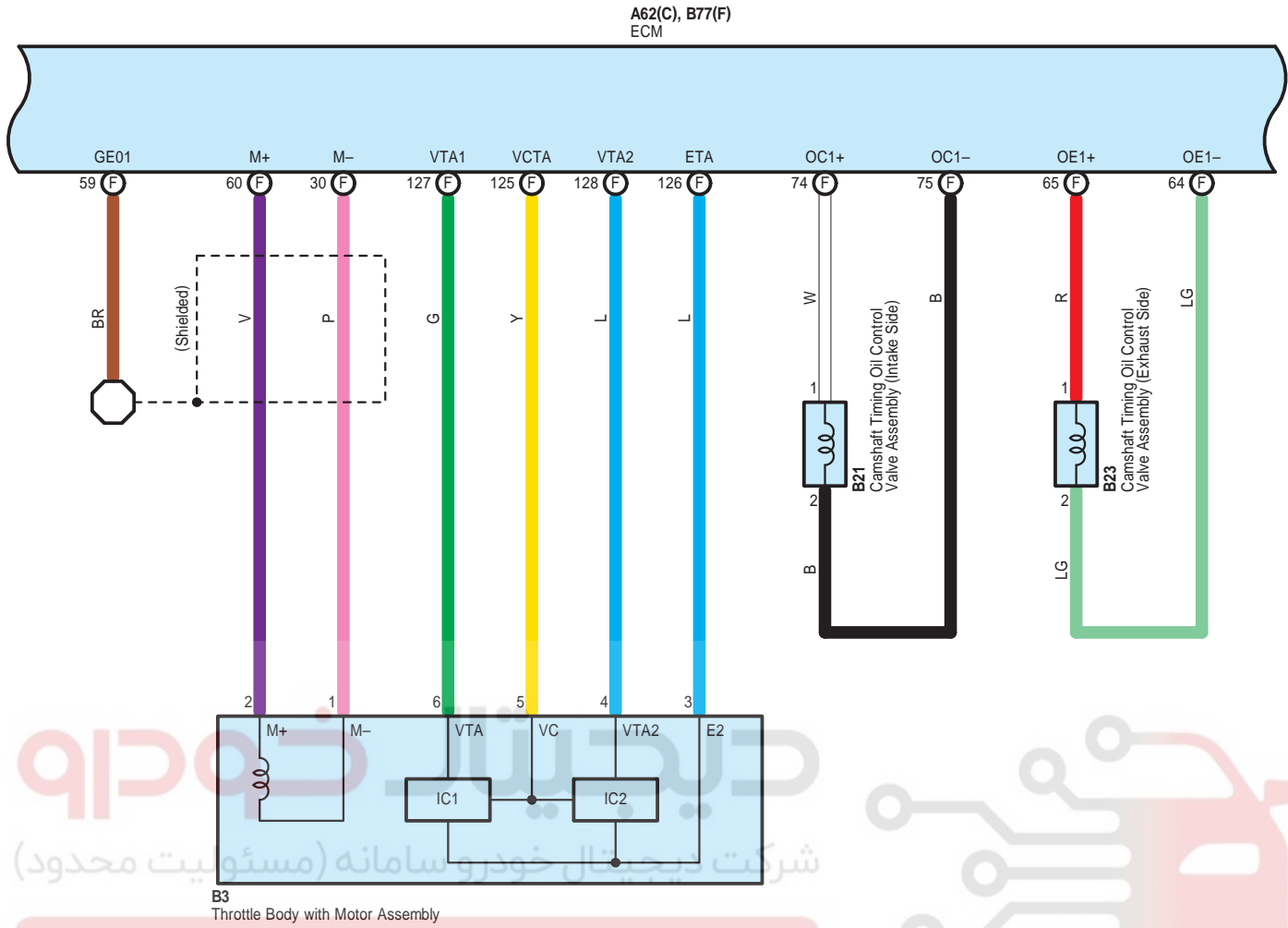

اولین سامانه دیجیتال تعمیرکاران خودرو در ایران

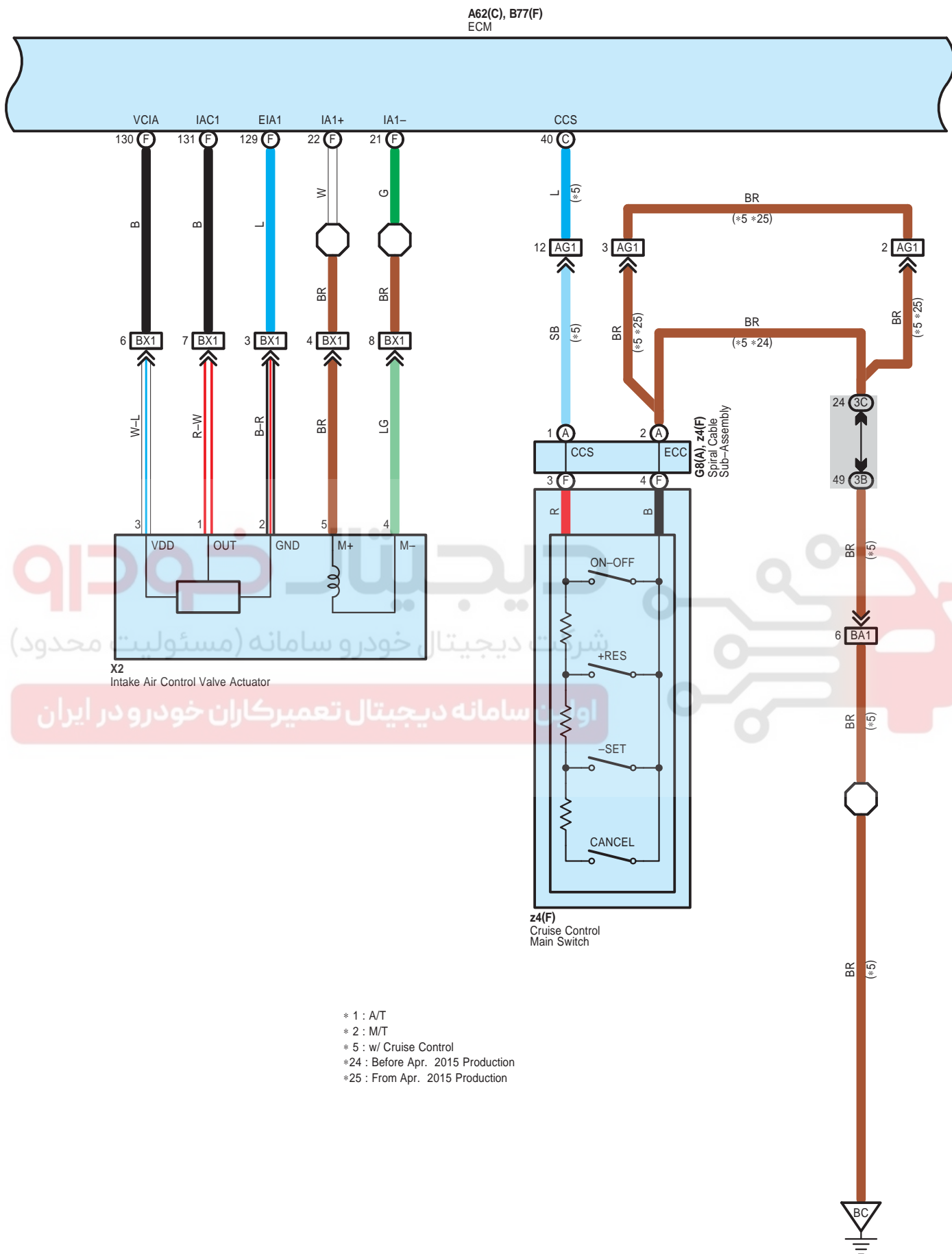

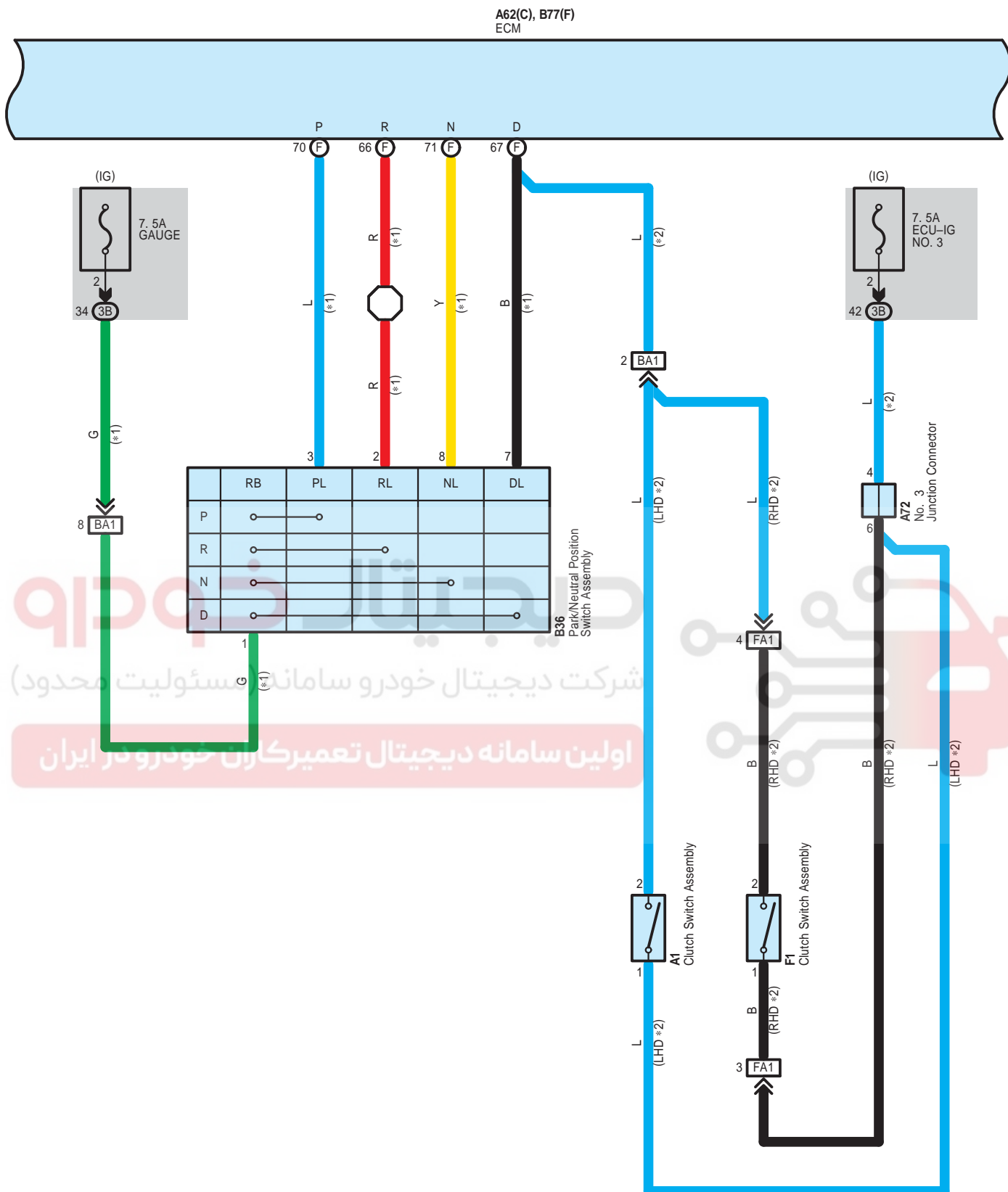

A62(C), B77(F)
ECM

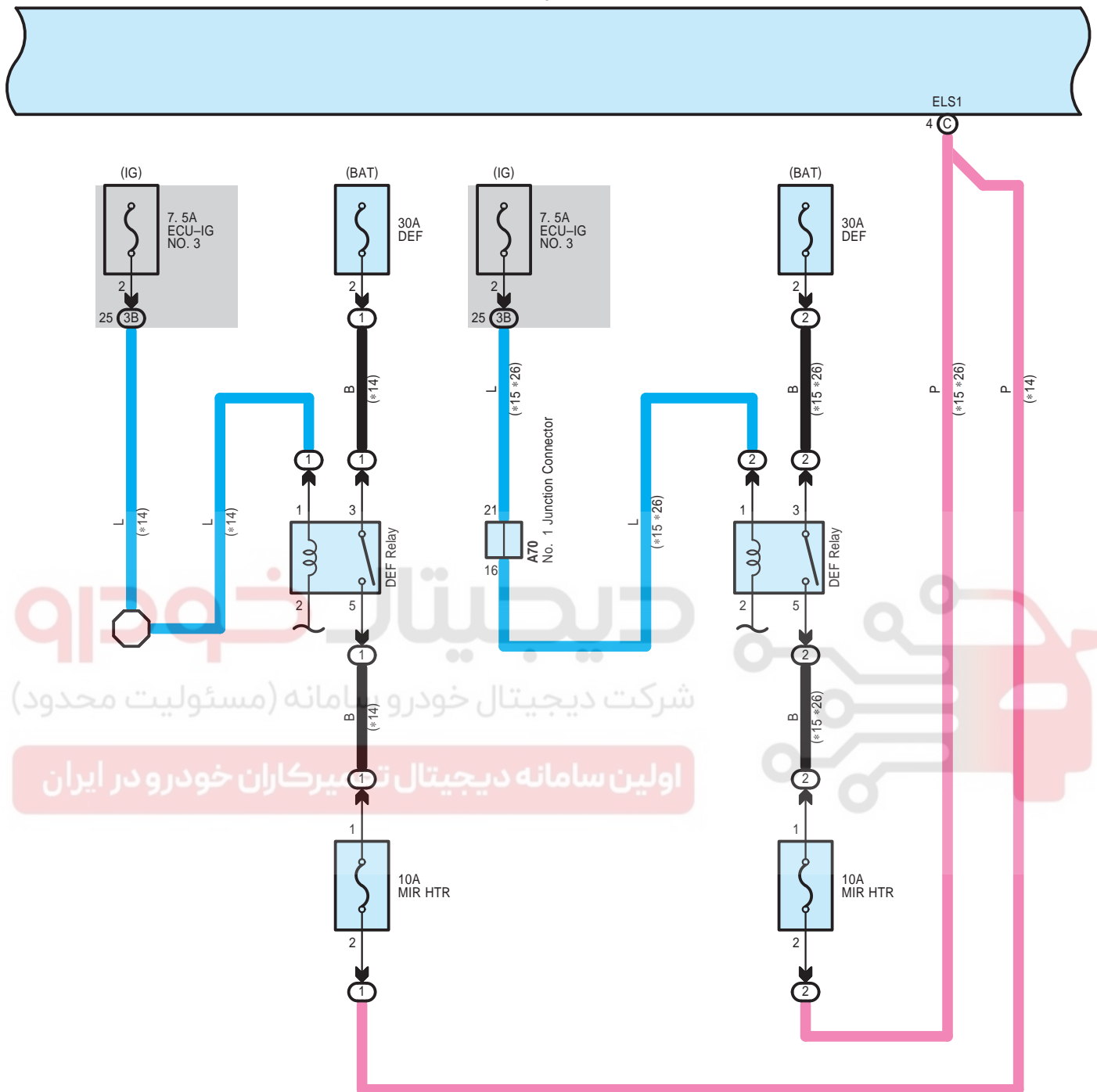

دیجیتال خودرو
شرکت دیجیتال خودرو سامانه (مسئولیت محدود)
اولین سامانه دیجیتال تیرکاران خودرو در ایران

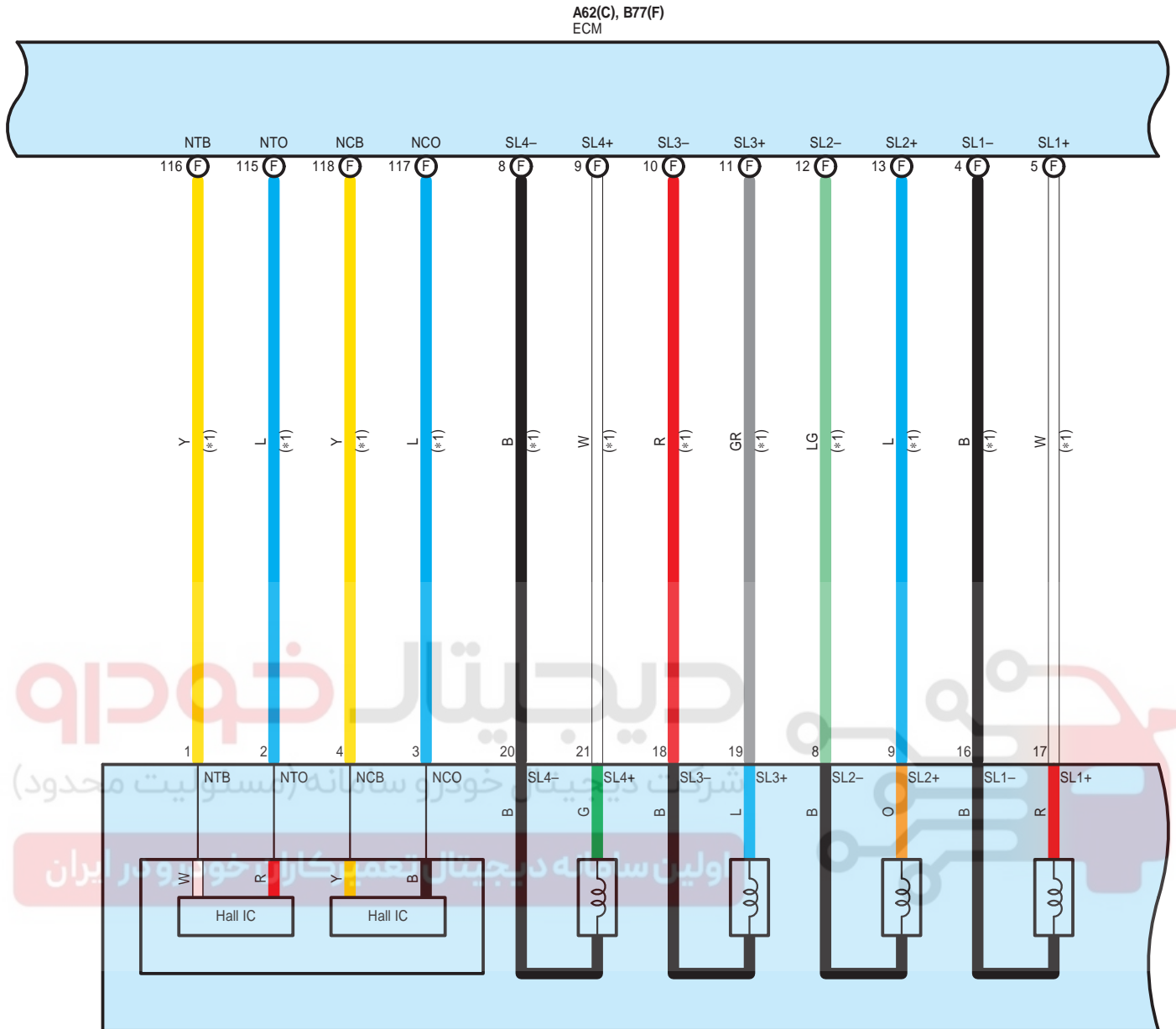

B78
ECT Solenoid (Transmission Wire)

* 1 : A/T
*14 : Korea
*22 : 2WD

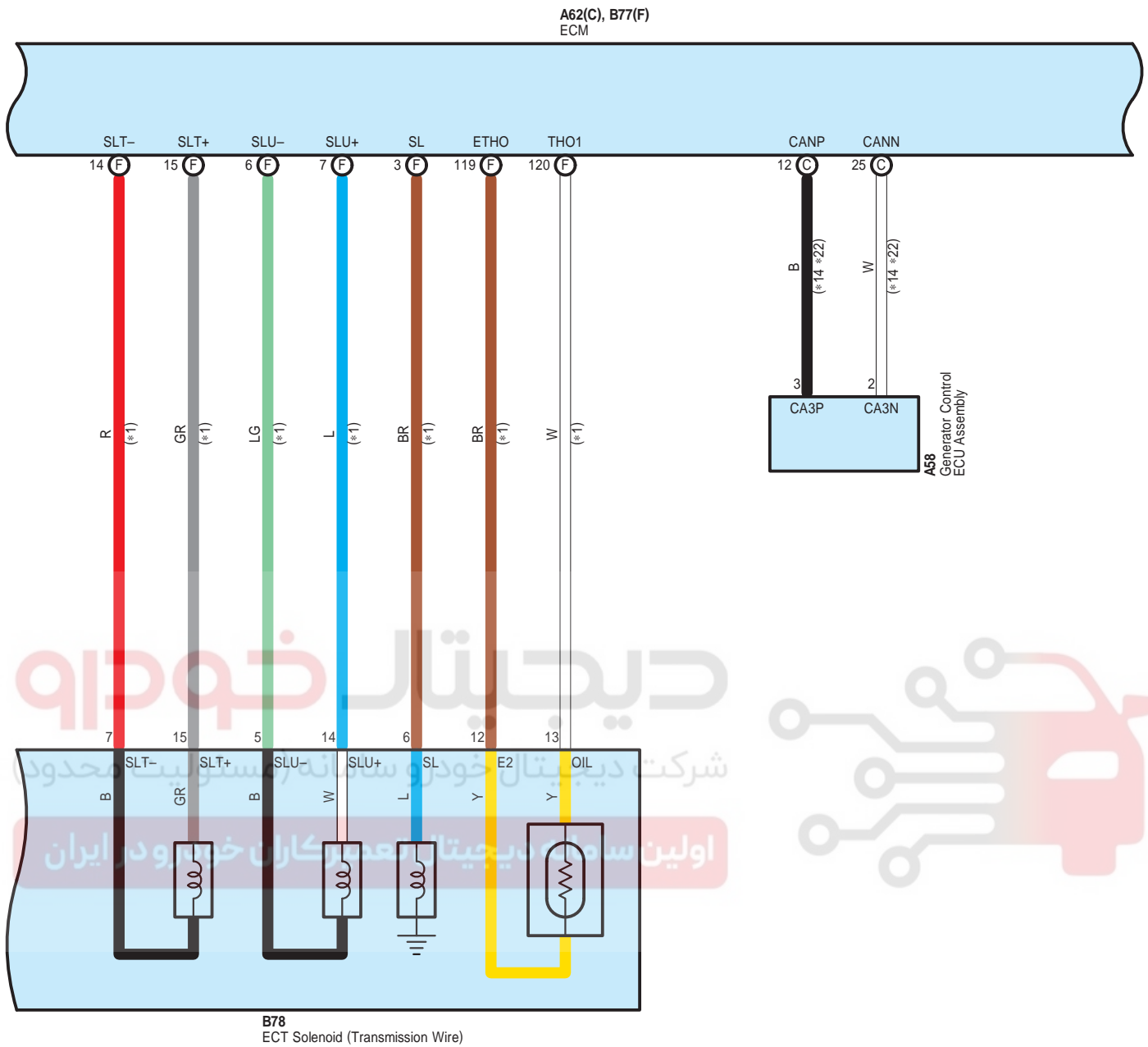

Cruise Control (2AR-FE) (Before Oct. 2015 Production), ECT and A/T Indicator (2AR-FE) (Before Oct. 2015 Production), Engine Control (2AR-FE) (Before Oct. 2015 Production)

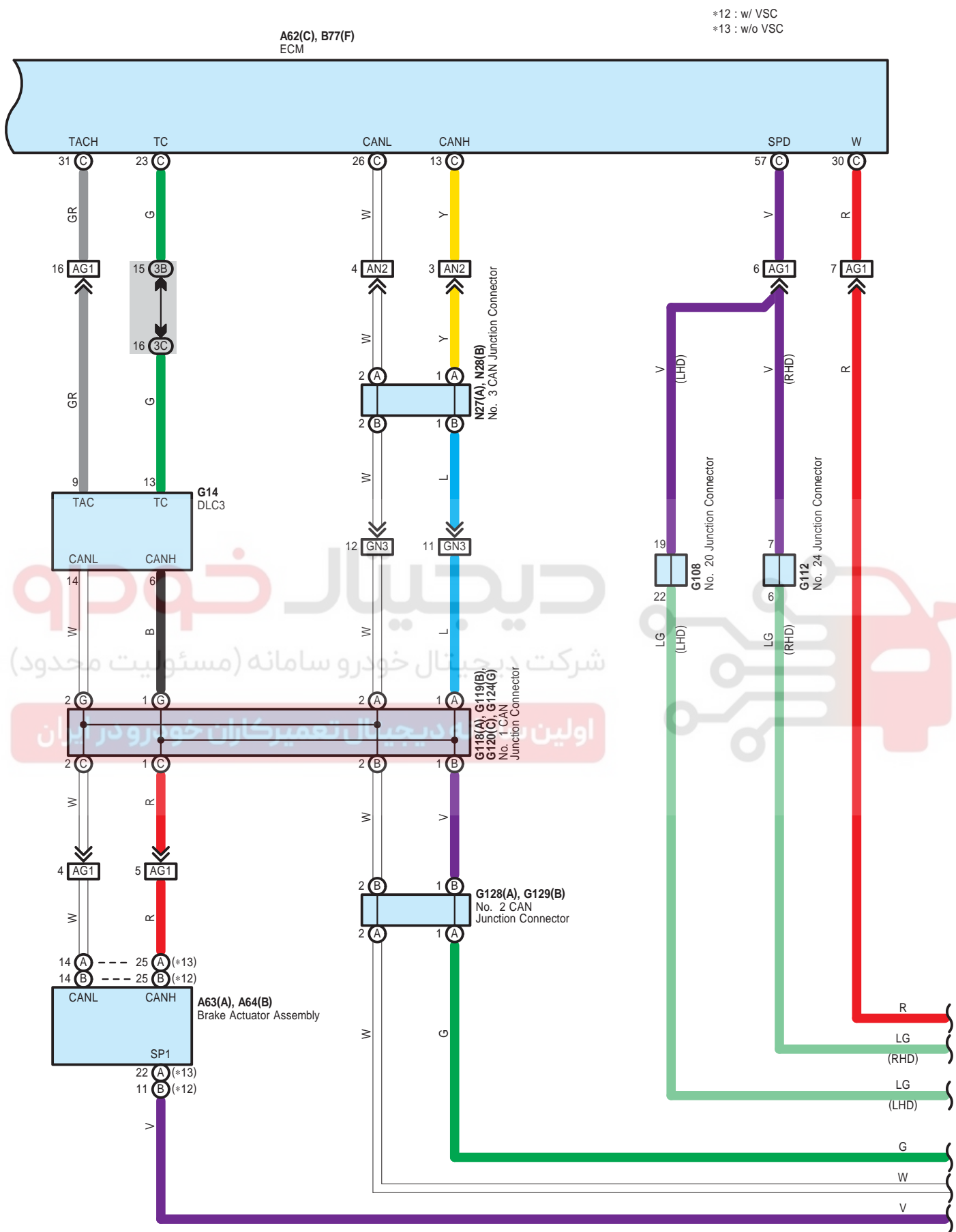

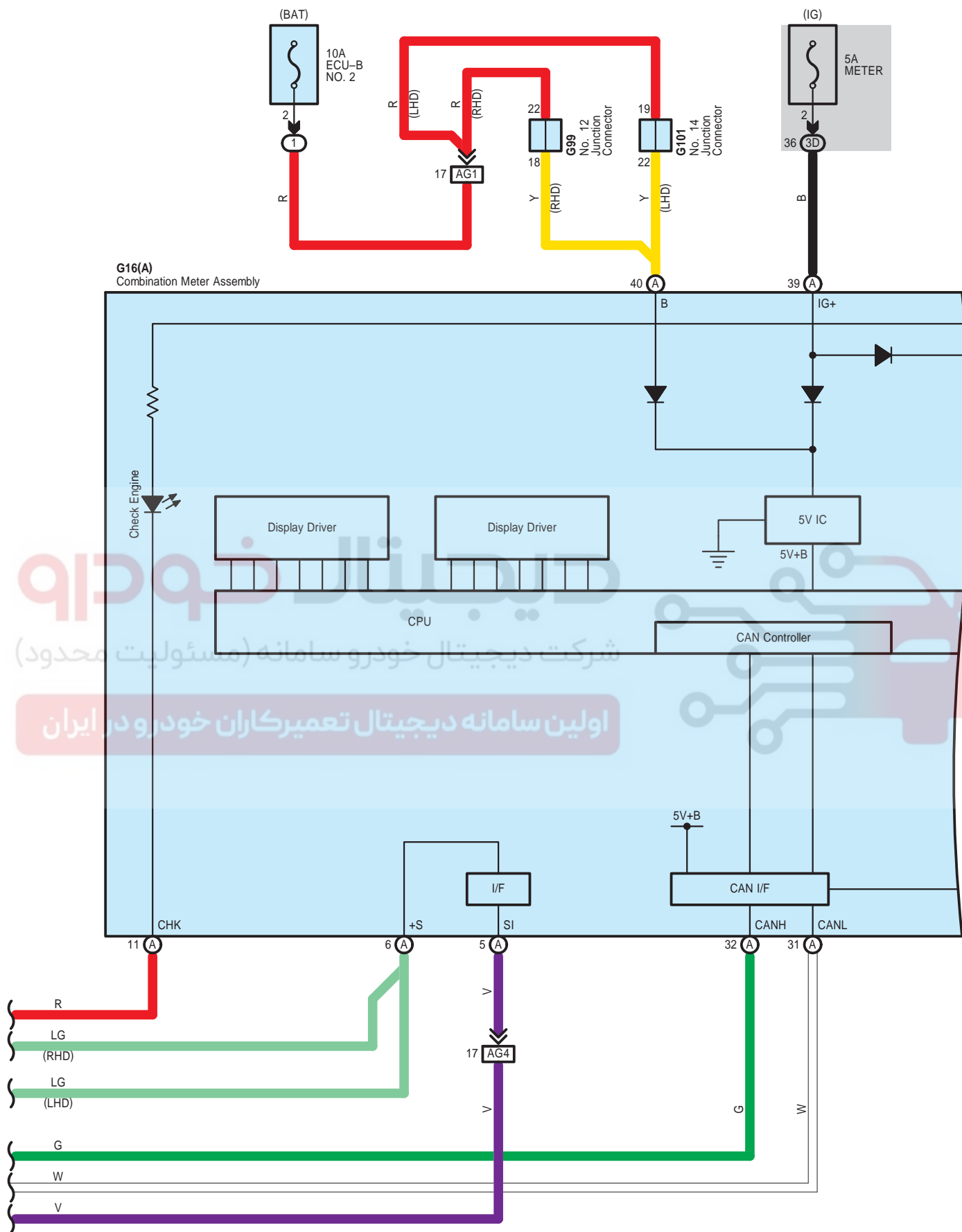

*23 : w/ Gear Shift Indicator

G16(A)
Combination Meter Assembly

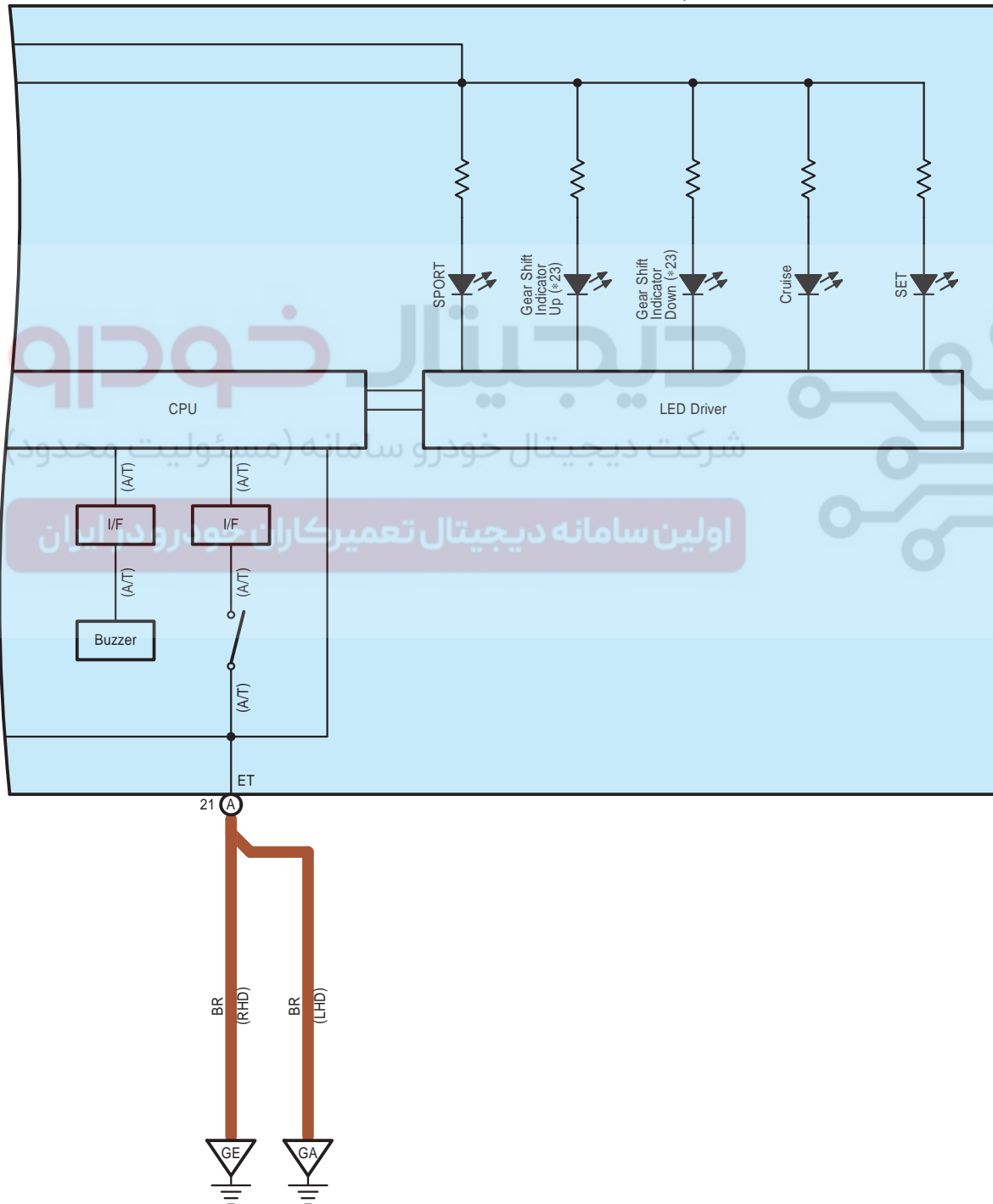

Cruise Control (2AR-FE) (Before Oct. 2015 Production), ECT and A/T Indicator (2AR-FE) (Before Oct. 2015 Production), Engine Control (2AR-FE) (Before Oct. 2015 Production)

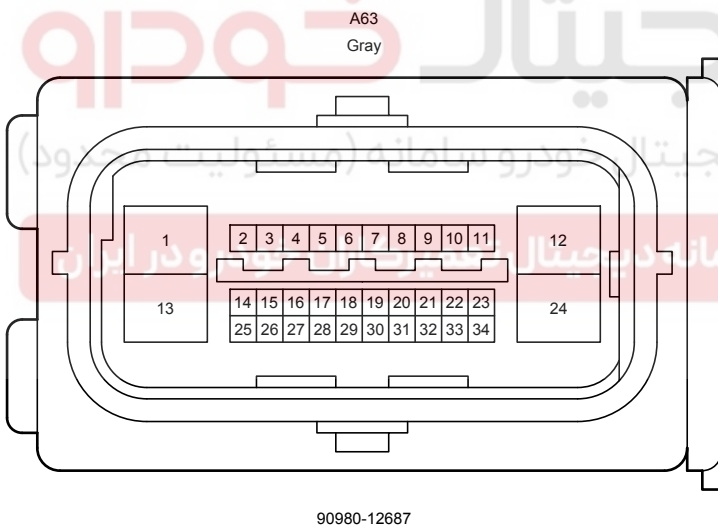
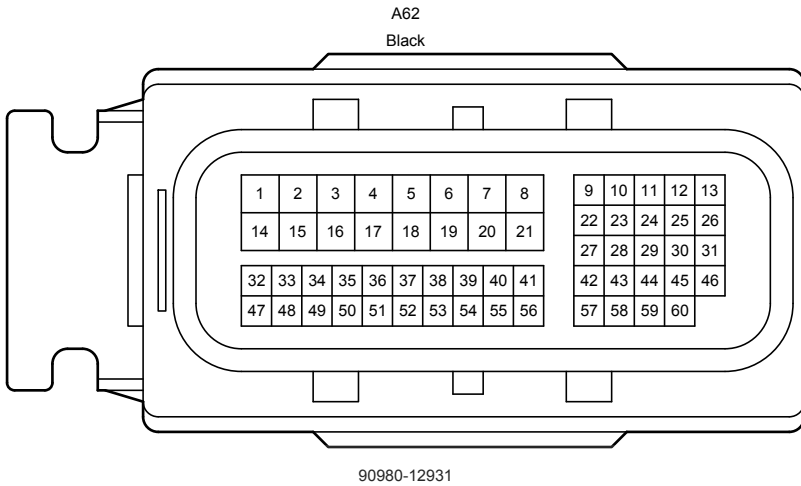
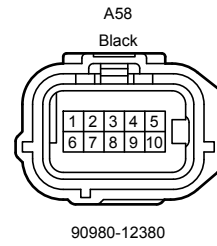
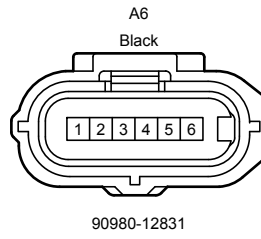
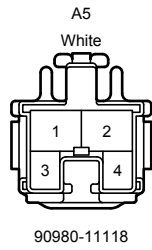
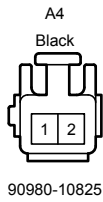
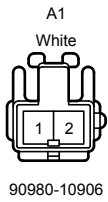

A64
Black

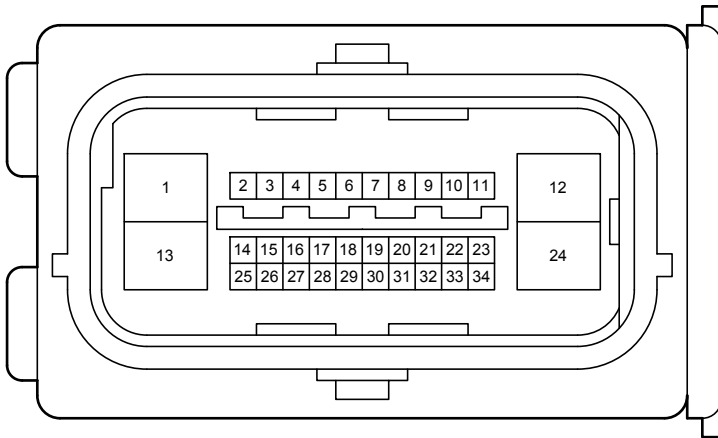

90980-12686

A70
White

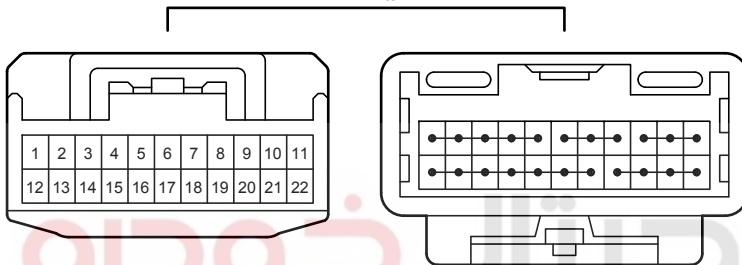

90980-12372

A72
White

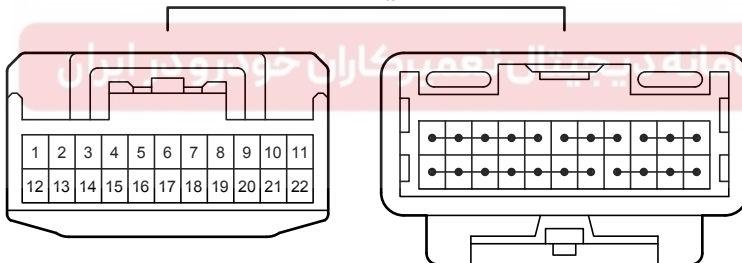

90980-12372

A73
Blue

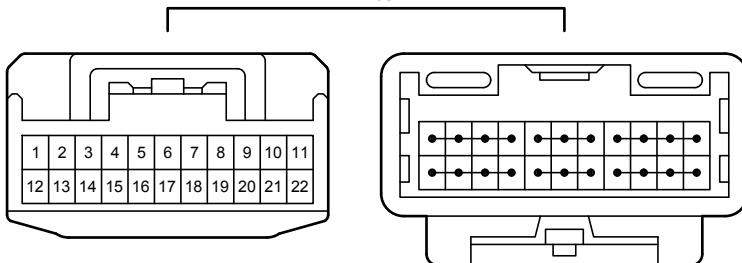

90980-12372



دیجیتال خودرو
شرکت دیجیتال خودرو سامانه (مسئولیت محدود)
اولین سامانه دیجیتال خودرو کاران خودروسازان

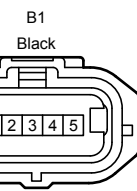

90980-12292

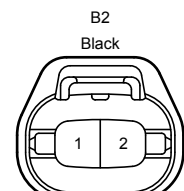

90980-11156

Cruise Control (2AR-FE) (Before Oct. 2015 Production), ECT and A/T Indicator (2AR-FE) (Before Oct. 2015 Production), Engine Control (2AR-FE) (Before Oct. 2015 Production)

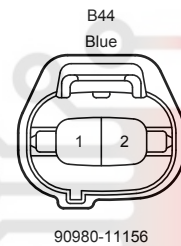
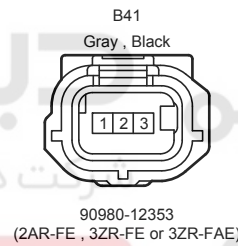
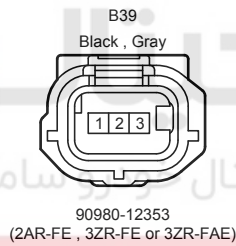
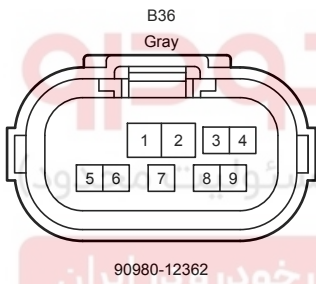
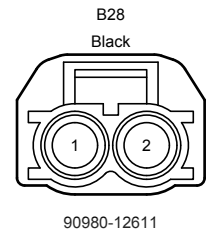
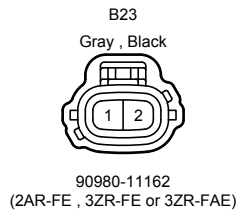
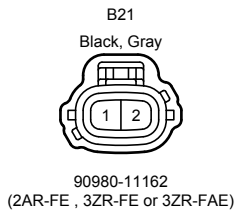
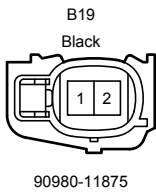
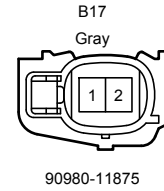
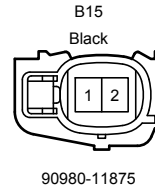
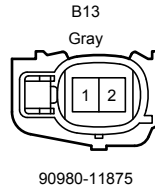
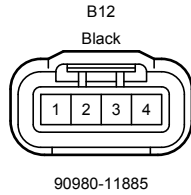
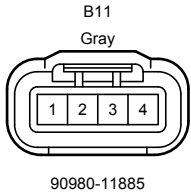
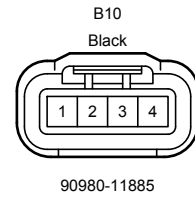
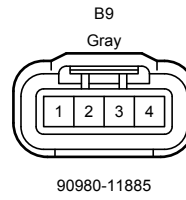
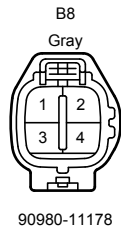
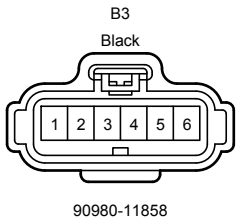

Cruise Control (2AR-FE) (Before Oct. 2015 Production), ECT and A/T Indicator (2AR-FE) (Before Oct. 2015 Production), Engine Control (2AR-FE) (Before Oct. 2015 Production)

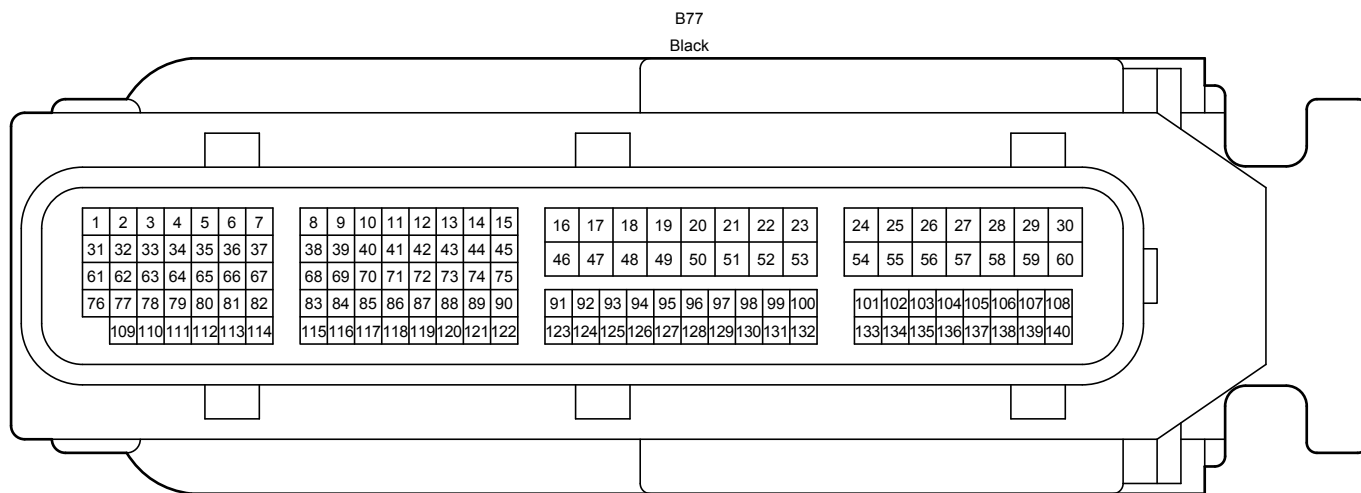

90980-12836

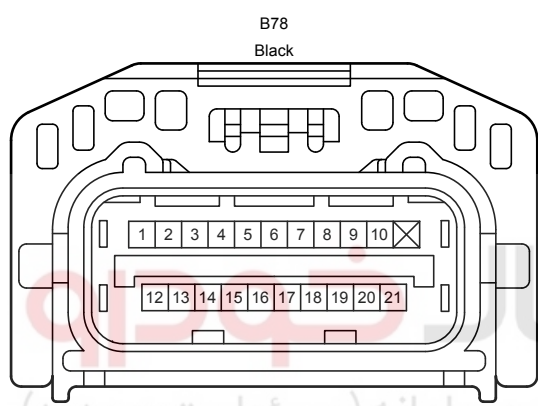

82824-33490

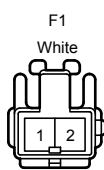

90980-10906

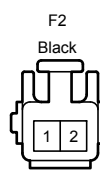

90980-10825

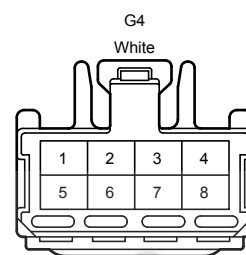

90980-11615

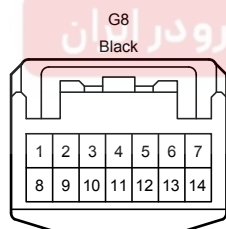

90980-12370

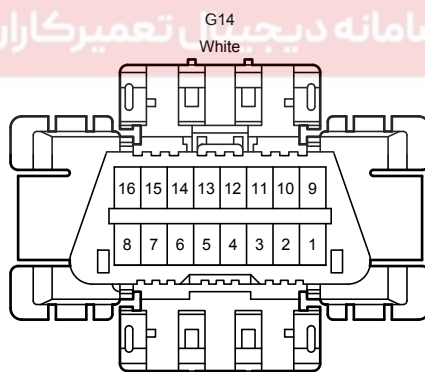

90980-11978

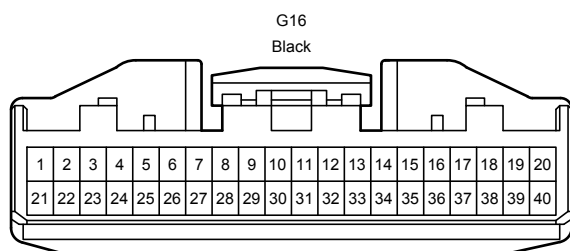

90980-12557

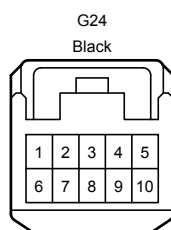

90980-12368

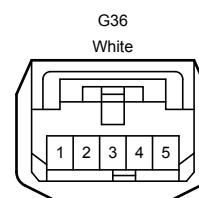

90980-12954

Cruise Control (2AR-FE) (Before Oct. 2015 Production), ECT and A/T Indicator (2AR-FE) (Before Oct. 2015 Production), Engine Control (2AR-FE) (Before Oct. 2015 Production)

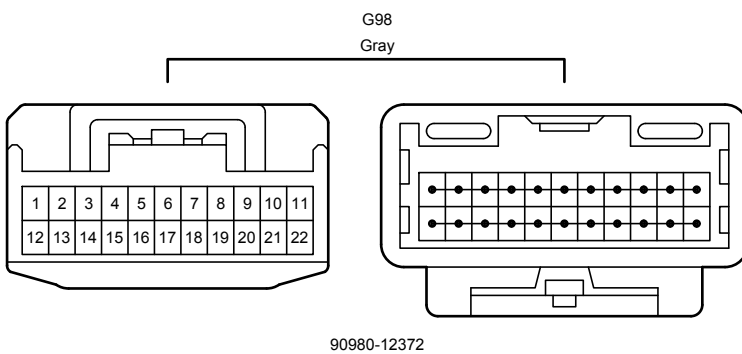
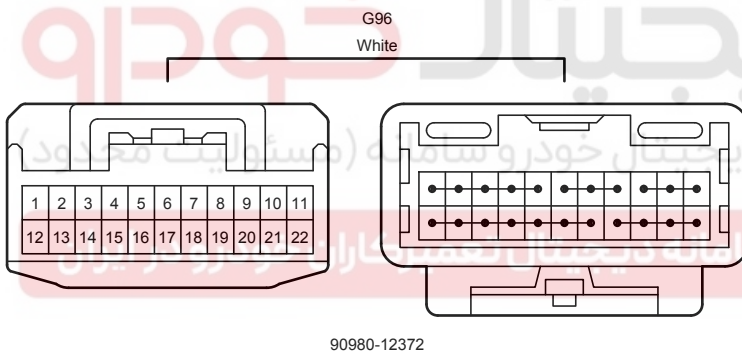
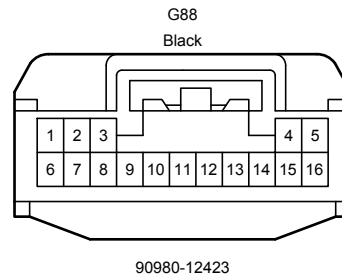
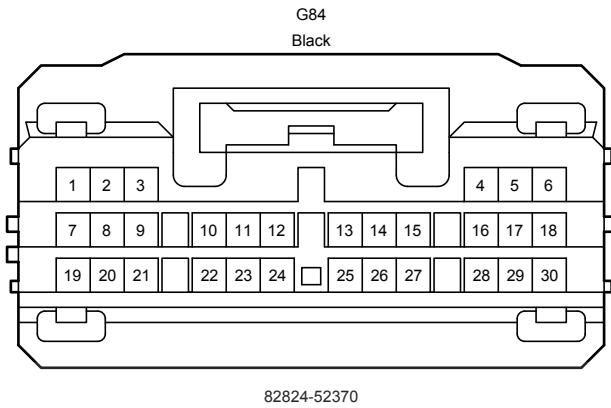
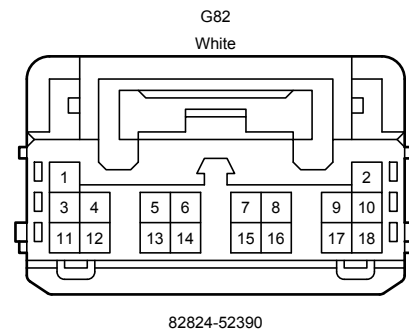
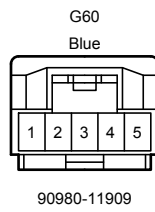
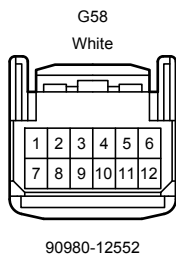
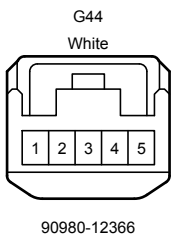

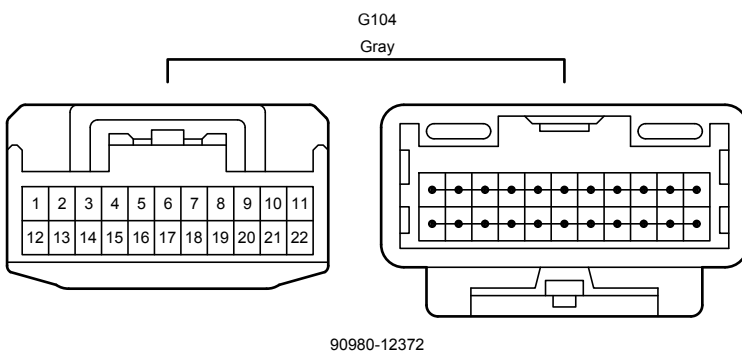
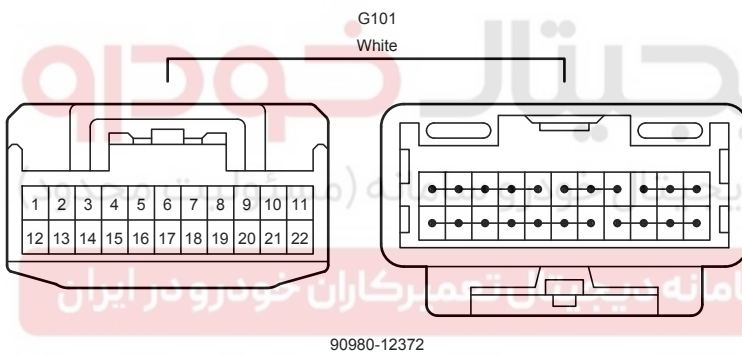
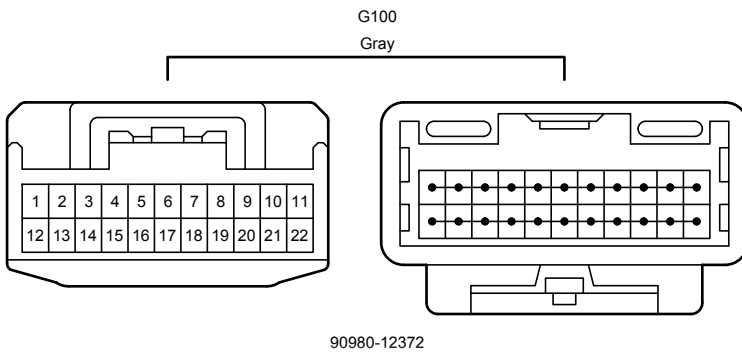
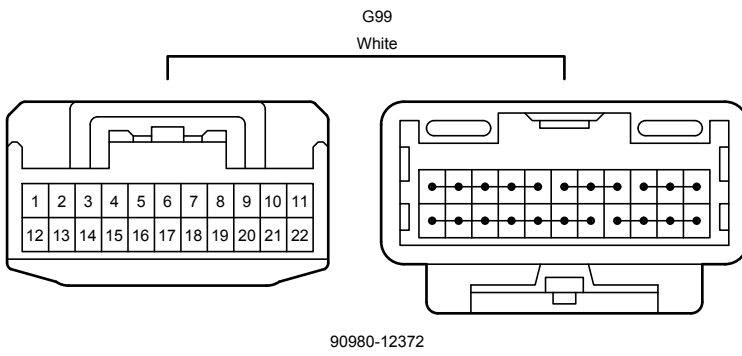

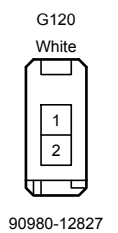
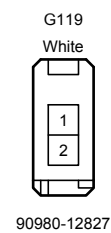
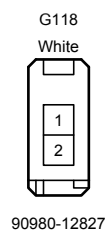
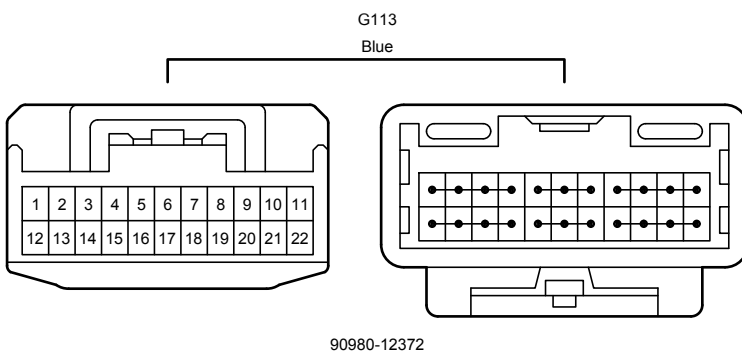
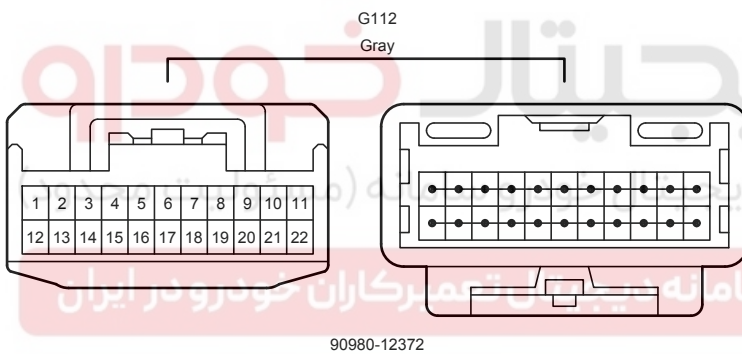
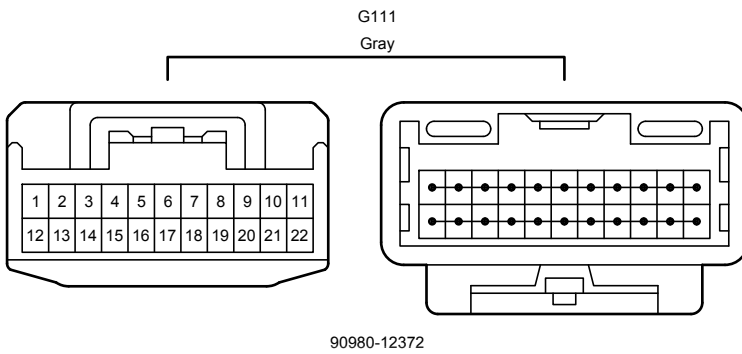
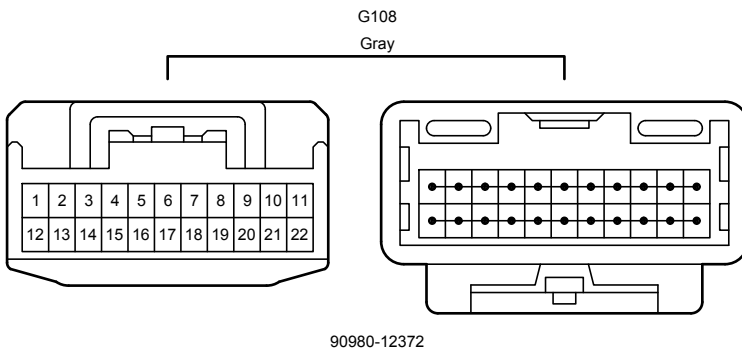

Cruise Control (2AR-FE) (Before Oct. 2015 Production), ECT and A/T Indicator (2AR-FE) (Before Oct. 2015 Production), Engine Control (2AR-FE) (Before Oct. 2015 Production)

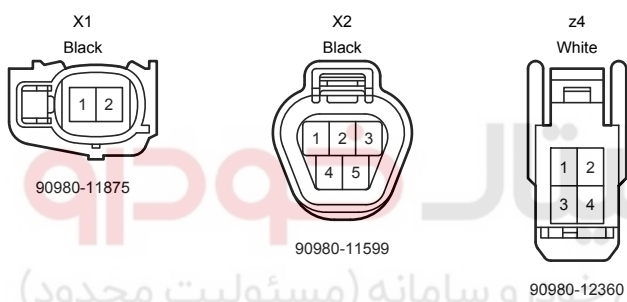
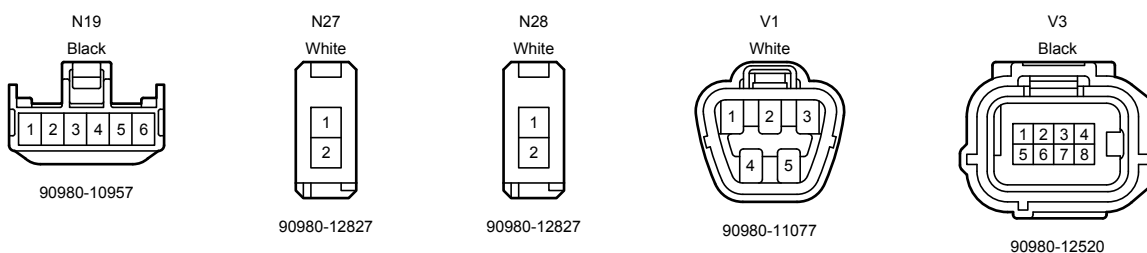
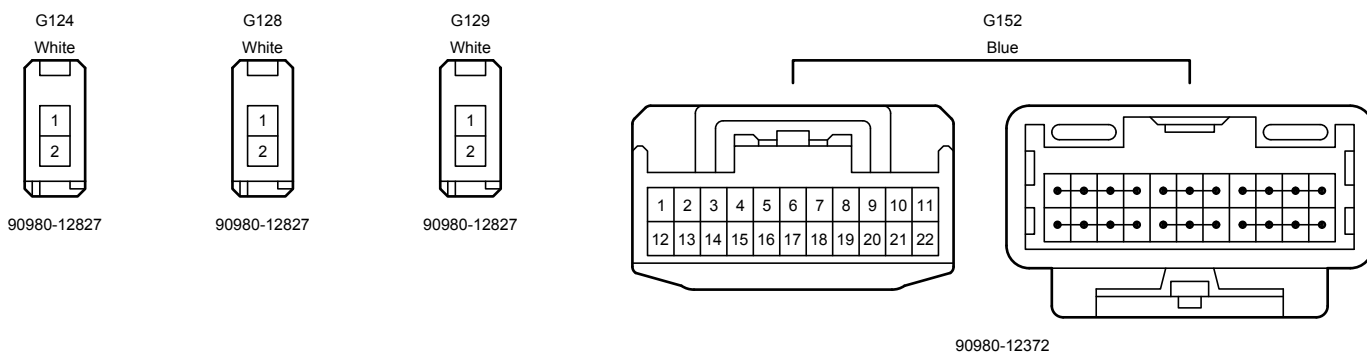

اولین سامانه دیجیتال تعمیراران خودرو در ایران

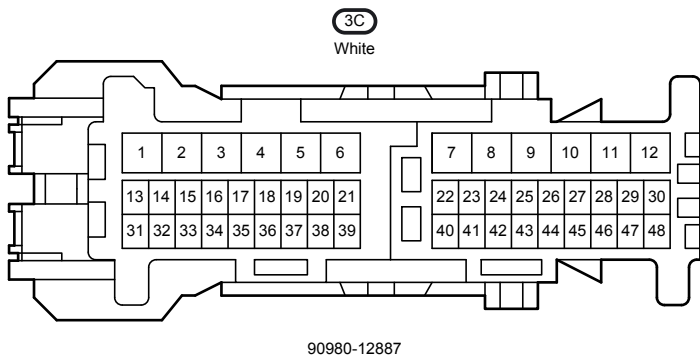
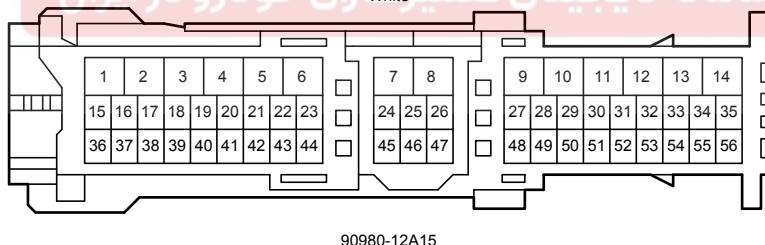

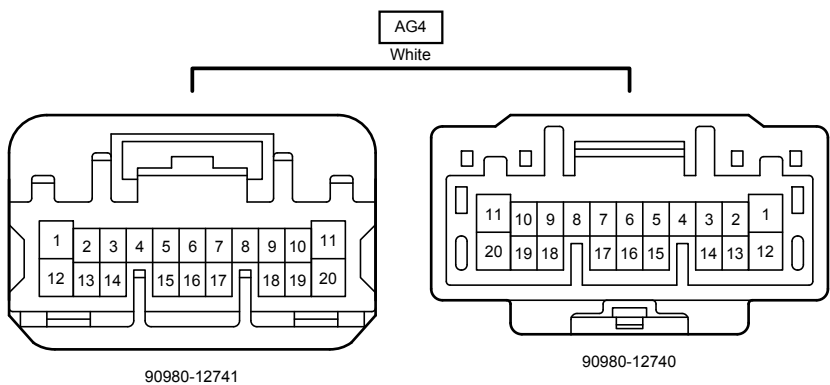
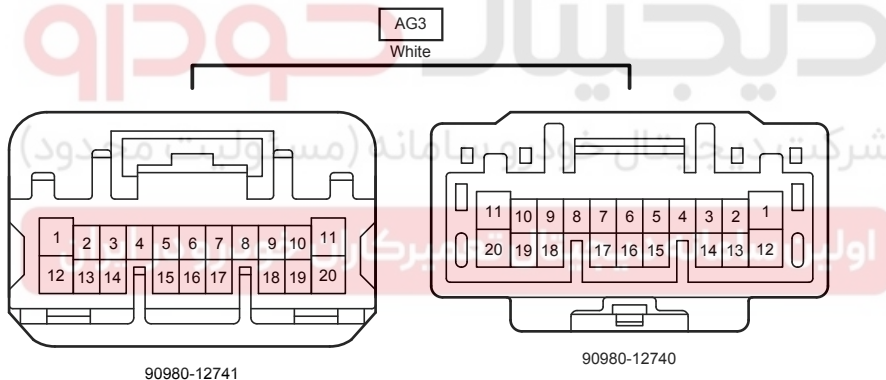
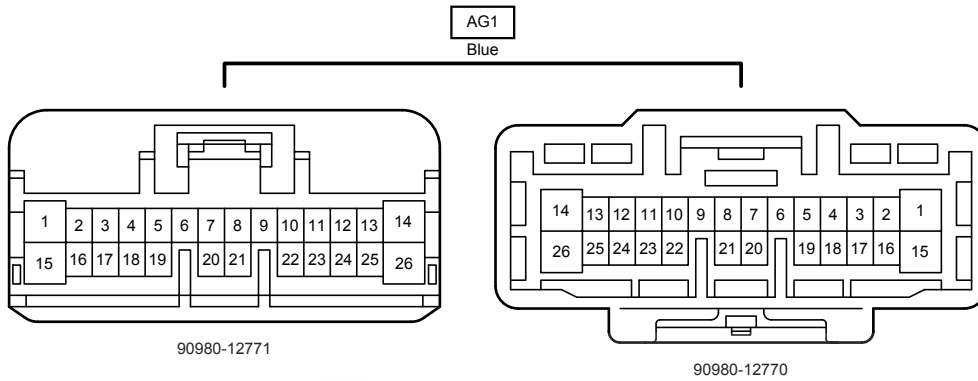
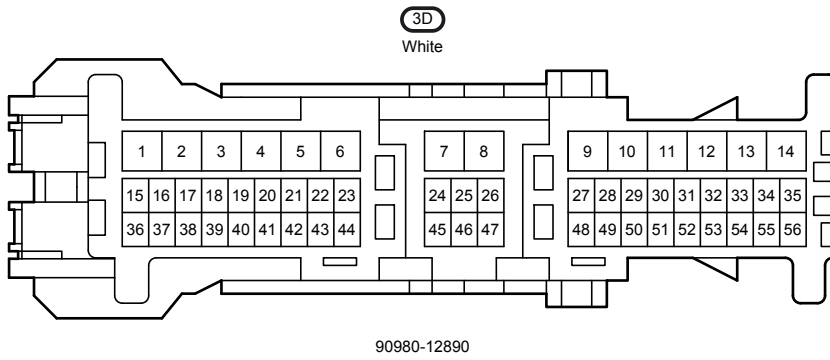

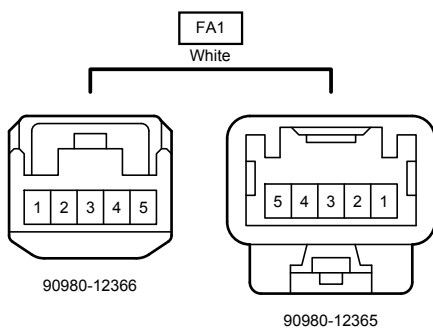
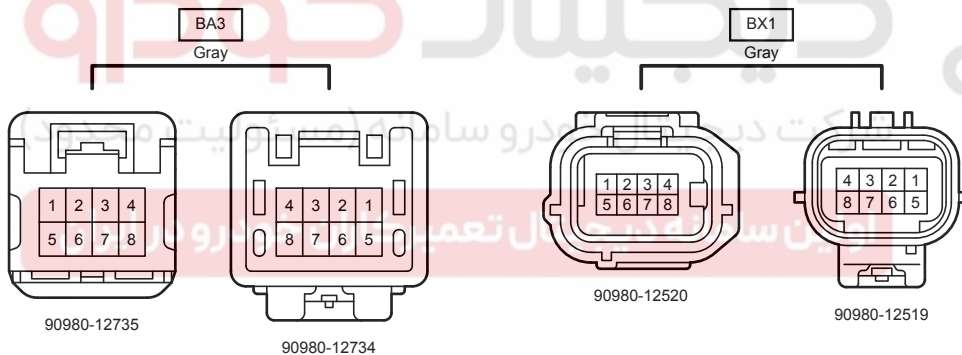
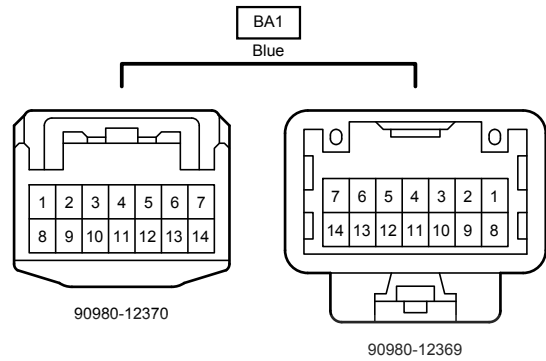
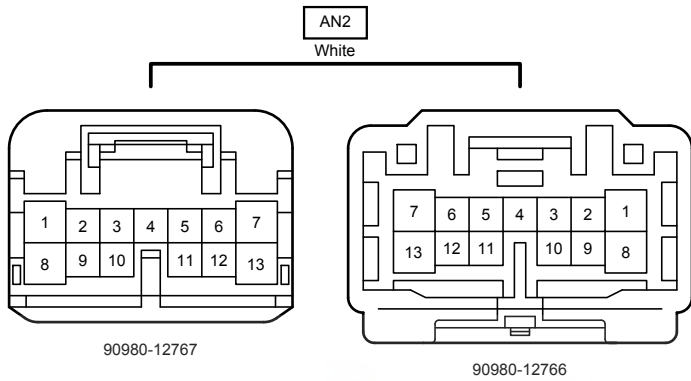
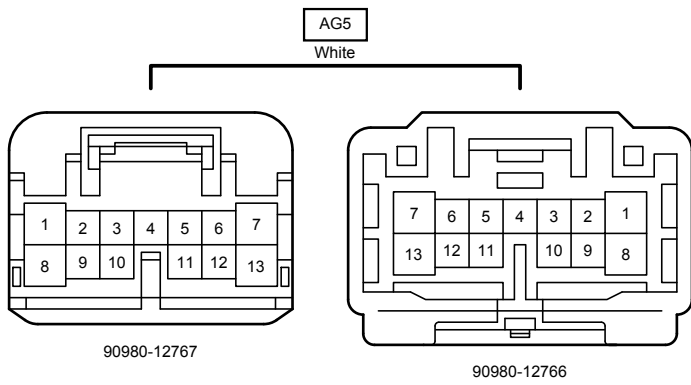

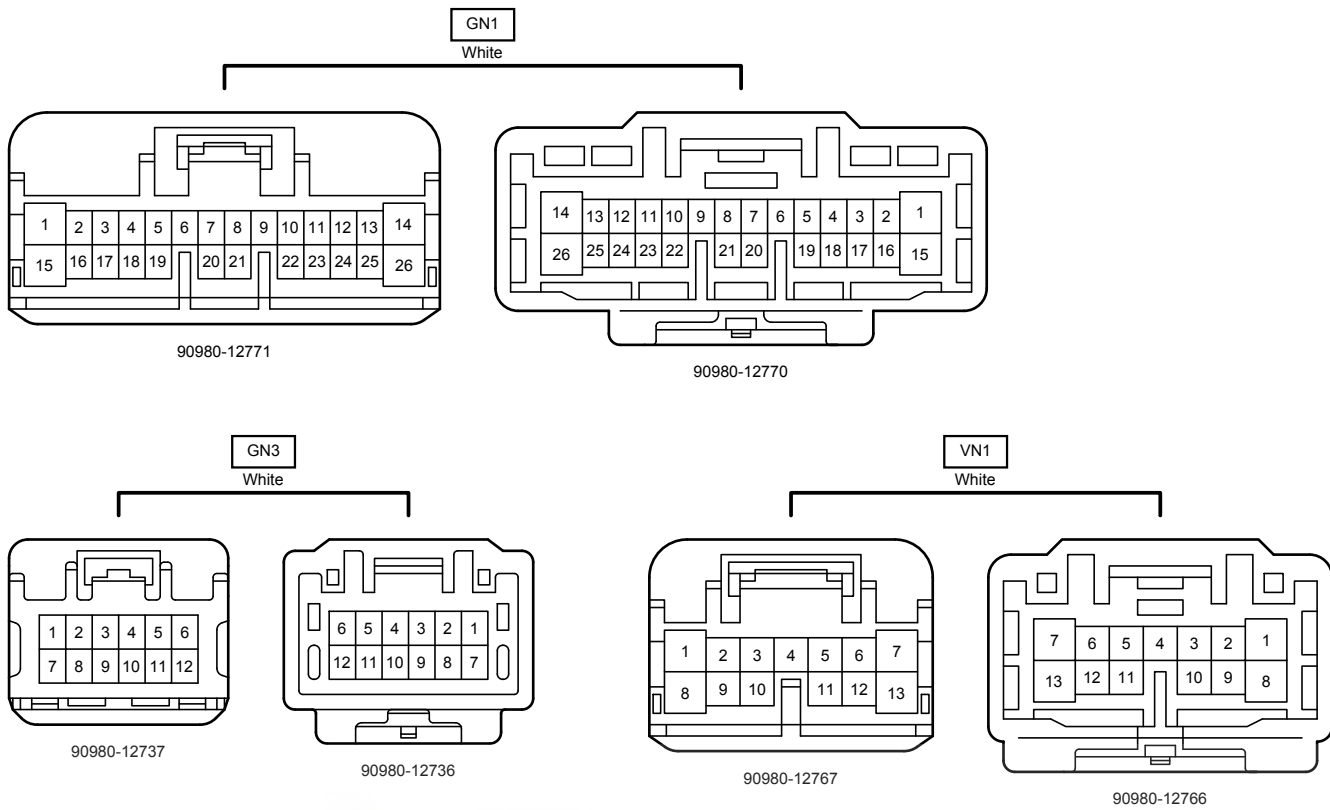

دیجیتال خودرو

شرکت دیجیتال خودرو سامانه (مسئولیت محدود)

اولین سامانه دیجیتال تعمیرکاران خودرو در ایران

