

**AIR BAG****8810-01/8810-03/8810-06/8810-11/8810-12/8810-16****INDEX****AIR BAG****GENERAL**

1. OVERVIEW (INCLUDING CURTAIN AIR BAGS) ..... 3

**OVERVIEW AND OPERATION PROCESS**

1. LOCATION AND RELATED COMPONENTS ..... 4
2. AIR BAG SYSTEM OPERATION PROCESS..... 6
3. AIR BAG MODULE AND RELATED COMPONENTS..... 8

**REMOVAL AND INSTALLATION**

- 8810-03 TROUBLE..... 20
- 8810-03 DRIVER AIR BAG ..... 24
- 8810-06 PASSENGER AIR BAG..... 25
- 8810-11 CURTAIN AIR BAG ..... 27
- 8810-12 CONTACT COIL ..... 29
- 8810-01 AIR BAG(SDM) ..... 30
- 8810-16 CURTAIN AIR BAG G SENSOR ..... 32

# دیجیتال خودرو

شرکت دیجیتال خودرو سامانه (مسئولیت محدود)

اولین سامانه دیجیتال تعمیرکاران خودرو در ایران



# AIR BAG

8810-03

## GENERAL

### 1. OVERVIEW (INCLUDING CURTAIN AIR BAGS)

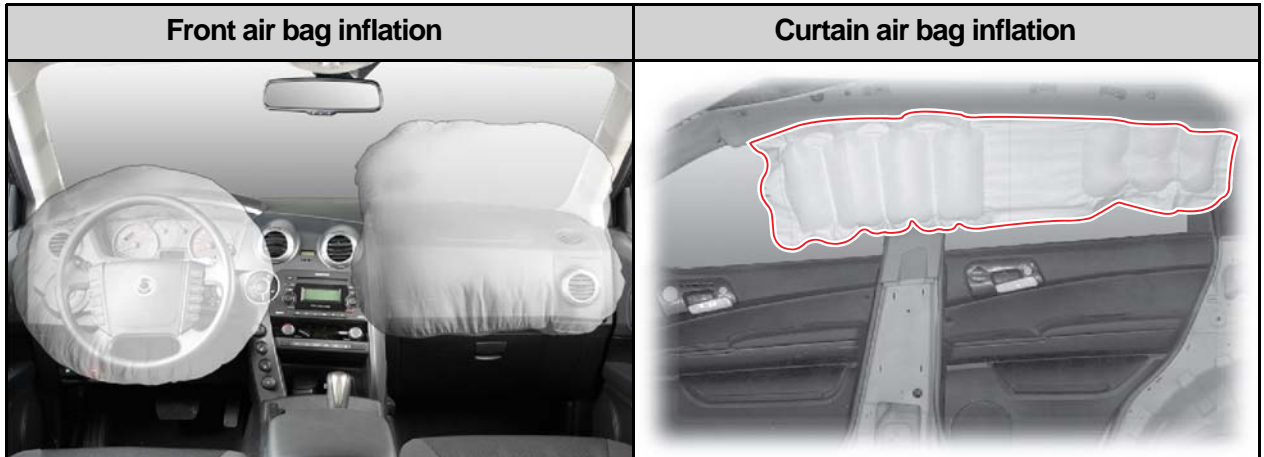

The air bag systems for this vehicle are not much different from the previous air bag system installed in other vehicles. The curtain air bags are installed at the bottom of the roof trim instead of the side air bag and they enhance the passenger's safety. The driver's and passenger's curtain air bags individually deploy.

When the front air bags deploy, the seat belt pretensioners retract the seat belts too.

Collision sensors, a kind of impact G (acceleration) sensor, detect the front and longitudinal collisions and determine whether or not to deploy air bags. The roles of each collision sensor are as below:

#### Front G sensors (inside the air bag unit)

1. Send signals to the front air bags and the driver's and front passenger's seat belt pretensioners. By the signal from this sensor, front air bags (driver's and passenger's air bags) deploy and the seat belt pretensioners of the driver's and passenger's seat belts retract seat belts.

#### Curtain air bag G sensors

1. These are located inside the left and right B-pillar panel bottoms. When a collision occurs, the air bag at the side of collision deploys accordingly. Please pay attention to that, in the case of the curtain air bag, only the air bag at the side of collision deploys, not both.

Once an air bag deploys, its repair parts vary according to the deployment situation and damage to the vehicle from collision. Needed repairs also slightly vary between the front air bags and the curtain air bags. The following are the differences:

Replacement parts when the front air bags deploy: the air bag units and their connection wires (connectors included), the seat belt pretensioners and their connection wires (connectors included), the entire front air bags, and the instrument panel (IP).

Replacement parts when a curtain air bag deploys: the new curtain air bag for the deployed side, the air bag unit and its connection wires (connectors included), the collision G sensor assembly for the curtain air bag, and the trims and roof headlining for the broken parts.

Modification basis	
Application basis	
Allocated VIN	

## OVERVIEW AND OPERATION PROCESS

### 1. LOCATIONS AND RELATED COMPONENTS

#### 1) LH

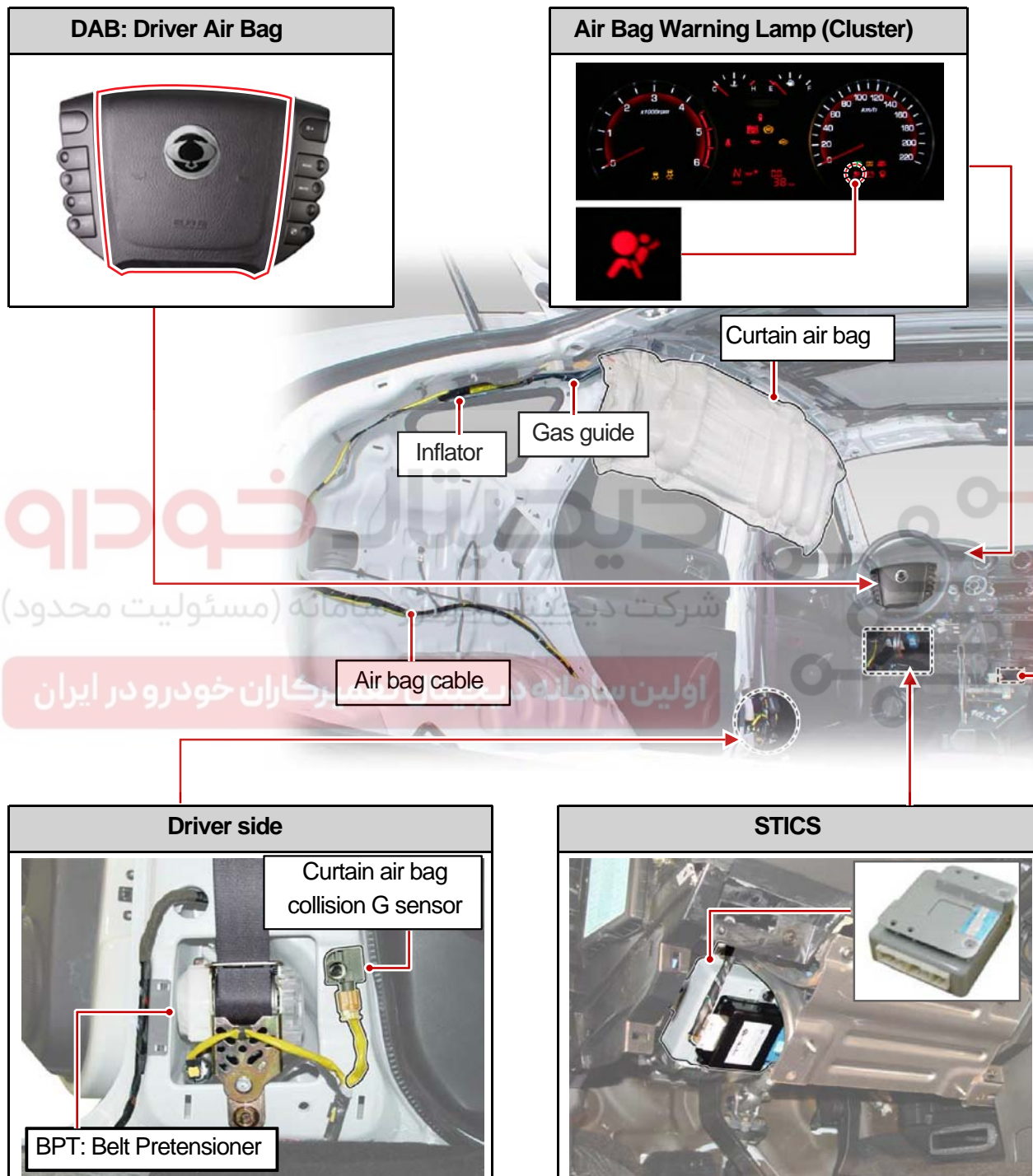

40 ms after receiving the air bag deployment signal at the vehicle speed 3 km/h or higher, it sends out the door UNLOCK signal for 5 seconds.

Modification basis	
Application basis	
Affected VIN	021 62 99 92 92

2) RH

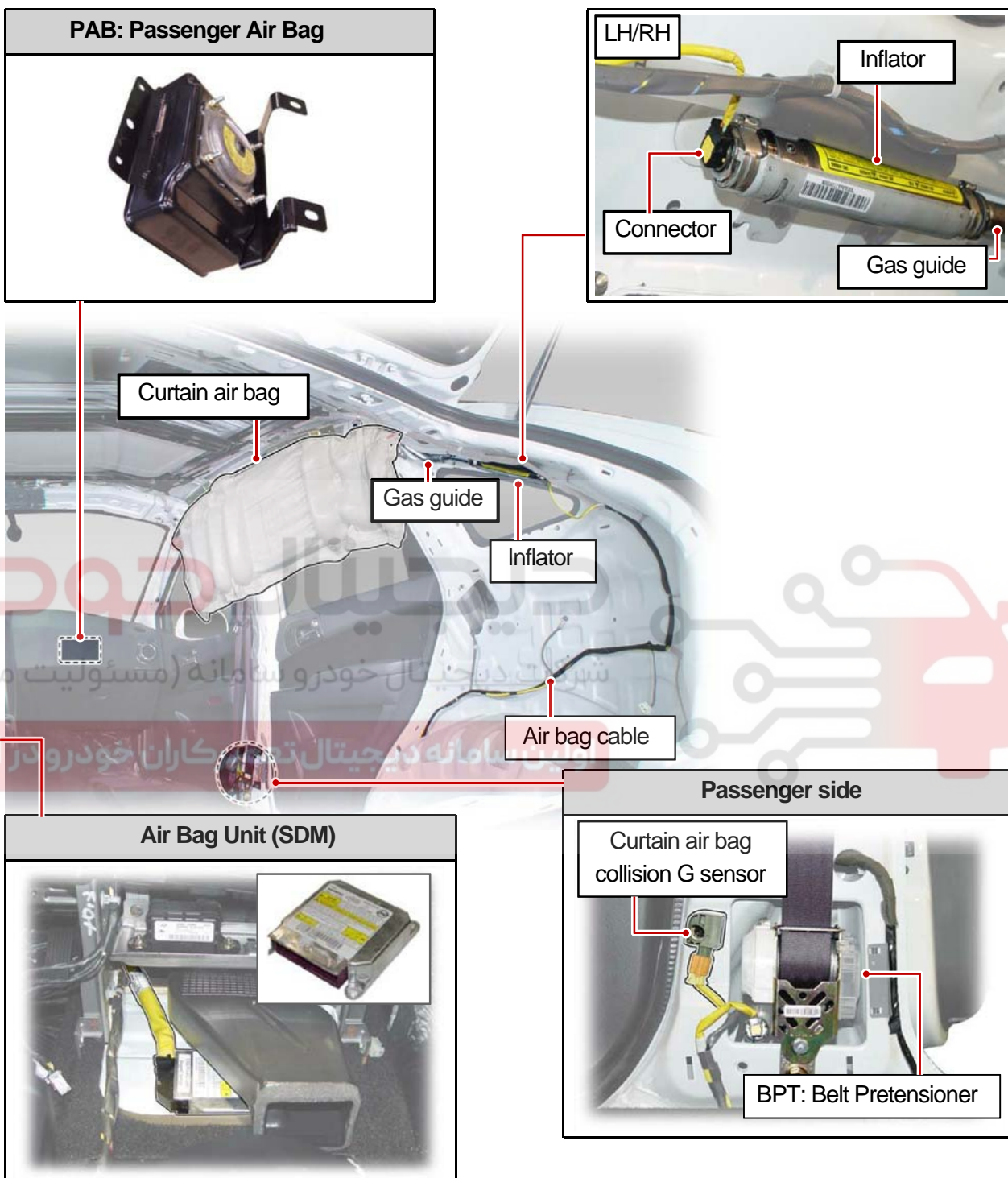

The collision G sensor is installed inside this. And it sends out signals to deploy the front air bags (driver's and passenger's air bags) and (or) the driver's and passenger's seat belt retensioners. When the front collision G sensor sends out only the air bag deployment signal, the signal deploys the two front air bags and activates their seat belt pretensioners.

AIR CONDITIONING  
AIR BAG  
SEAT  
SUNROOF  
BODY INTERIOR  
BODY EXTERIOR  
BODY REPAIR

Modification basis	
Application basis	
Allocated VIN	

## 2. AIR BAG SYSTEM OPERATION PROCESS

The overall air bag operation process and its functions and roles are broadly explained in this block diagram.

This diagram summarizes and highlights the functions adopted by Ssangyoung Motors.

### 1) Air Bag System Block Diagram (Functions and Roles Included)

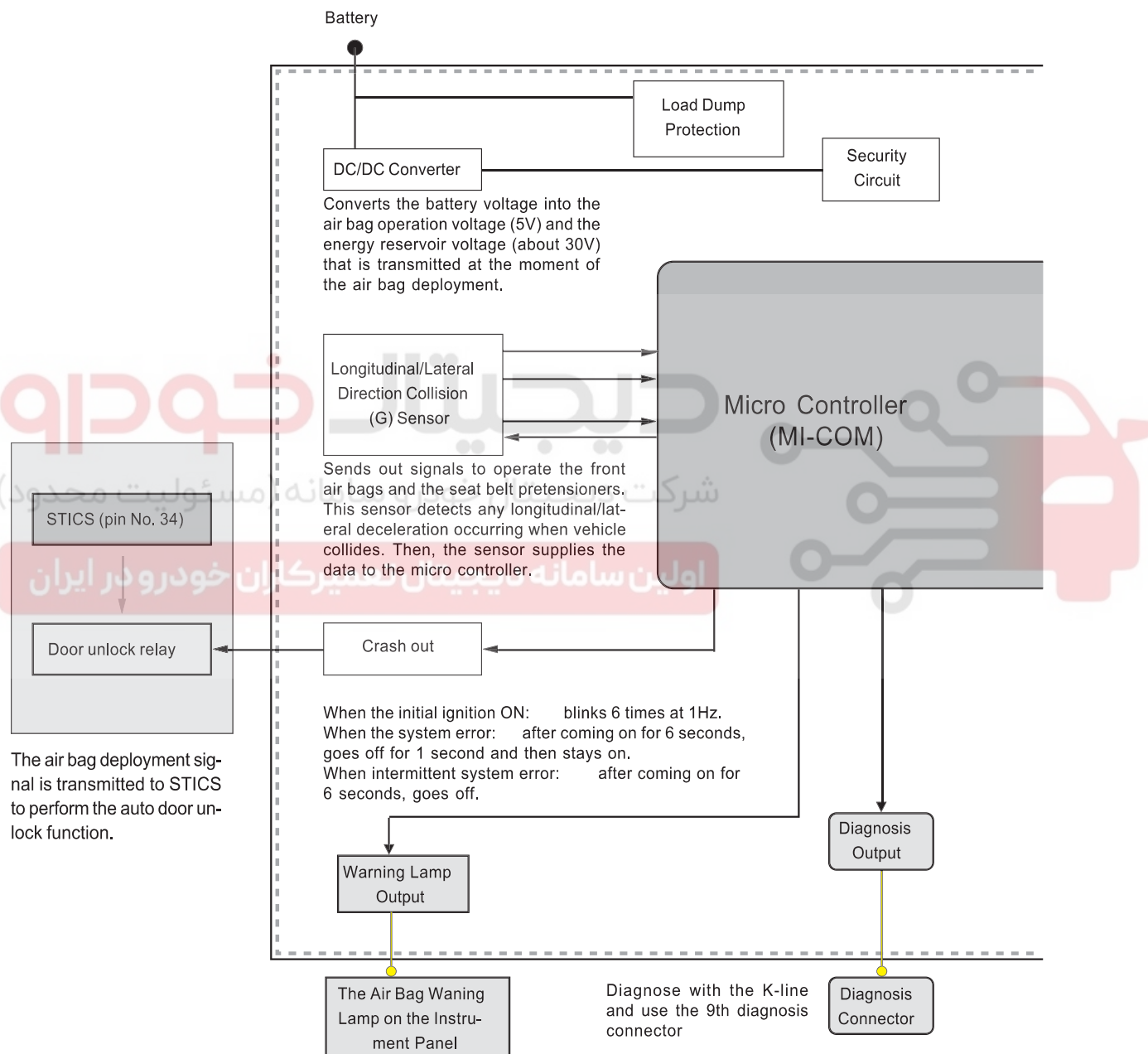

Modification basis	
Application basis	
Affected VIN	021 62 99 92 92

The watch dog monitors the micro controller, the air bags, and the seat belt pretensioners in the air bag unit. When any error occurs, it turns on the air bag warning lamp.

When the front air bags deploy, the driver's air bag and the front passenger's air bag deploy simultaneously and their seat belt pretensioners also simultaneously retract their seat belts.

The air bag unit monitors conditions of the air bags and the seat belt pretensioners. When any error occurs, it stores the failure diagnostic code or turns on the air bag warning lamp on the instrument panel.

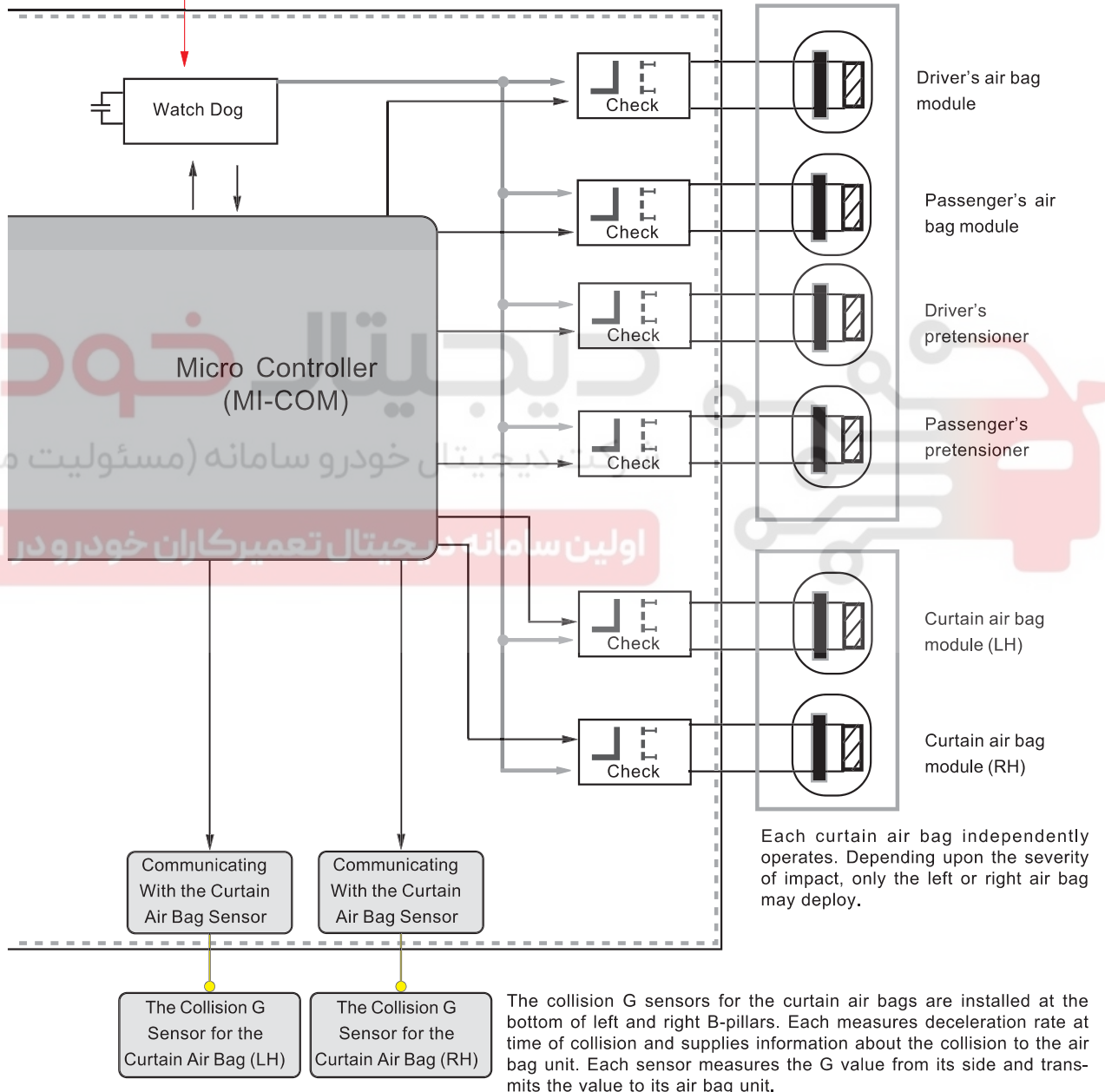

Modification basis	
Application basis	
Allocated VIN	

### 3. AIR BAG MODULE AND RELATED COMPONENTS

This section describes the air bag module installed in ACTYON. The module consists of the inflator, the cushion, and the mounting cover.

#### 1) DAB (Driver Air Bag)

The driver's air bag is installed inside the steering wheel. If the acceleration sensor (inside the air bag unit) is activated by the deceleration from vehicle collision, the detonation is fired by the electrical signal of the air bag unit.

Then, the detonation sets off explosives and nitrogen gas is generated.

At this point, the air bag very quickly deploys and the gas is emitted from the relieving hole to absorb impact upon the driver.



#### (1) Components

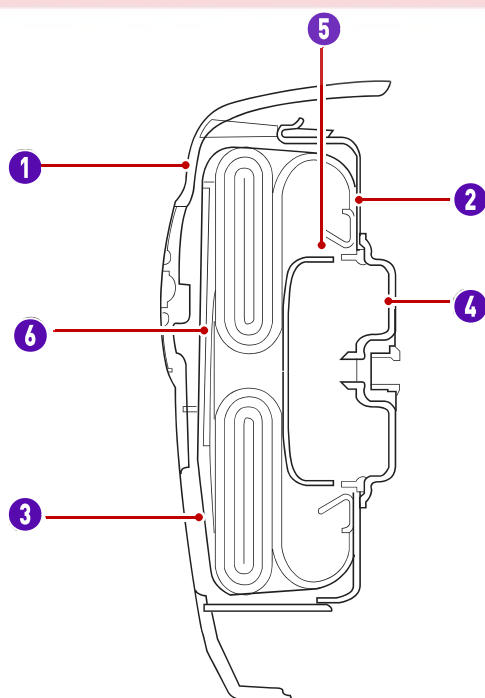

1. Air bag cover
2. Air bag housing
3. Air bag cushion (approx. 50 liters)
4. Inflator\* (approx. 190 Kpa)
5. Retainer ring
6. Horn switch

#### Inflator\*

The inflator is composed of the detonator, explosives, and the gas generator. It inflates air bag when vehicle collides.

Modification basis	
Application basis	
Affected VIN	021 62 99 92 92



## 2) PAB (Passenger Air Bag)

The passenger's air bag is installed inside the instrument panel above the glove box. Its operation process is the same as the driver's one. The driver's air bag, the passenger's air bag, and the seat belt pretensioners on both seats are made to operate together.

When the collision G sensor inside the air bag unit sends a collision signal, the air bag unit instantaneously applies a high current to the driver's and passenger's air bags and the seat belt pretensioners on both seats, fires the detonator in the inflator, and inflates the air bag cushions (curtain air bags independently operate in case of the side collisions).



### (1) Components

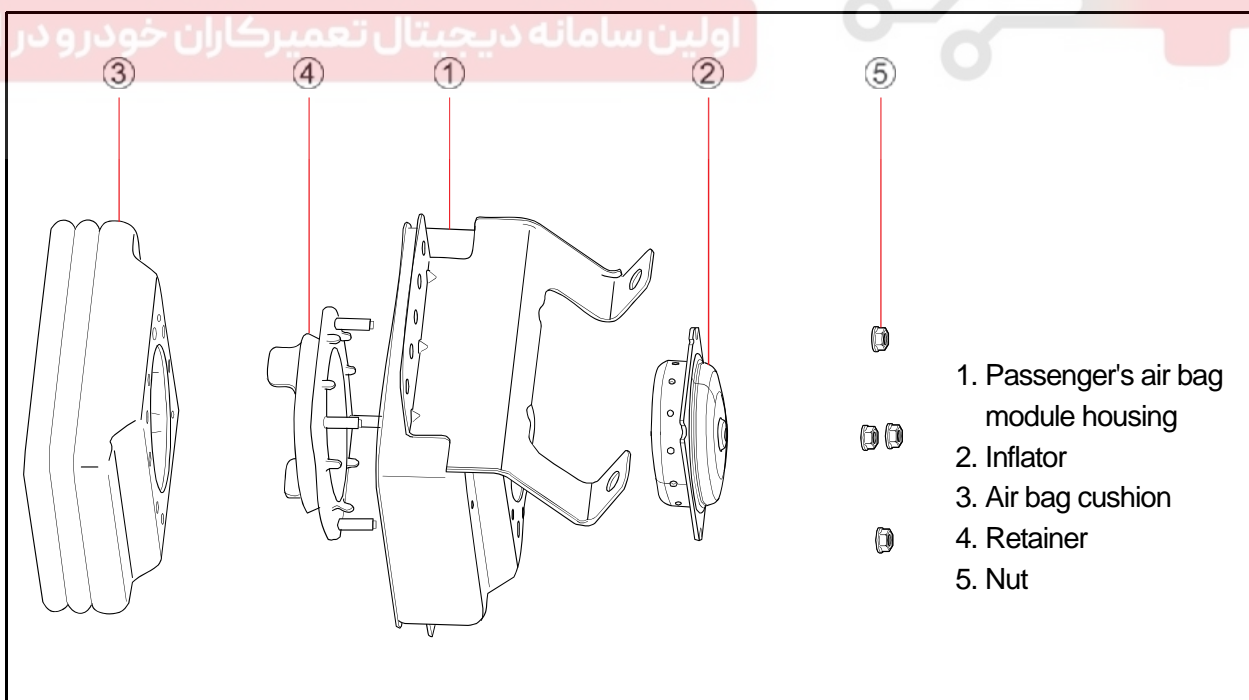

Modification basis	
Application basis	
Allocated VIN	

### 3) CAB (Curtain Air Bag)

The curtain air bags are installed on both sides of the roof side rails (inside the headlinings). Each curtain air bag is also composed of the air bag cushion and the inflator that has the detonator, explosives, and the gas generator.

The deployment process logic of the curtain air bag is slightly different from the one of the front air bag (including pretensioner), but it is the same as the conventional side air bag.

A collision situation is detected by the curtain air bag collision G sensor installed at the lower side of the B-pillar. The signal is transmitted to the air bag unit. The air bag unit instantly inflates the necessary air bag necessary by sending a high current.

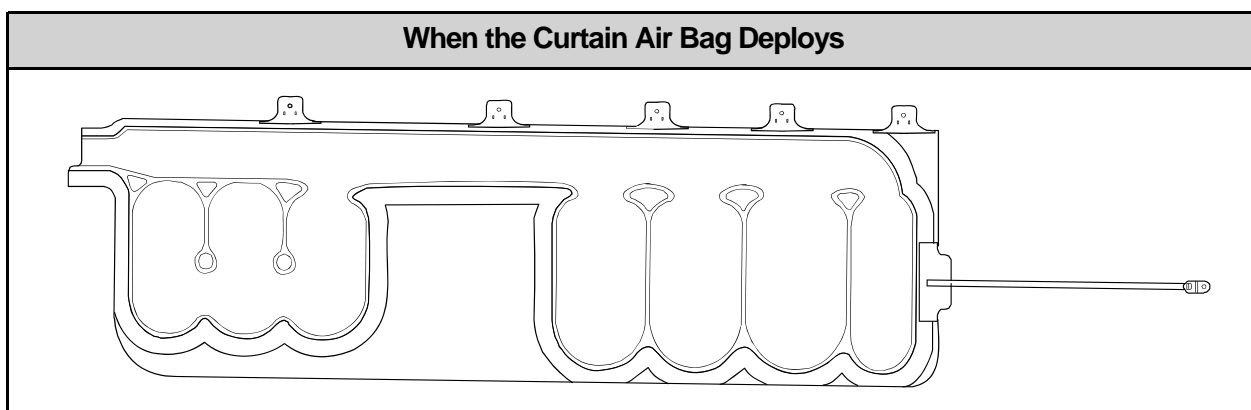
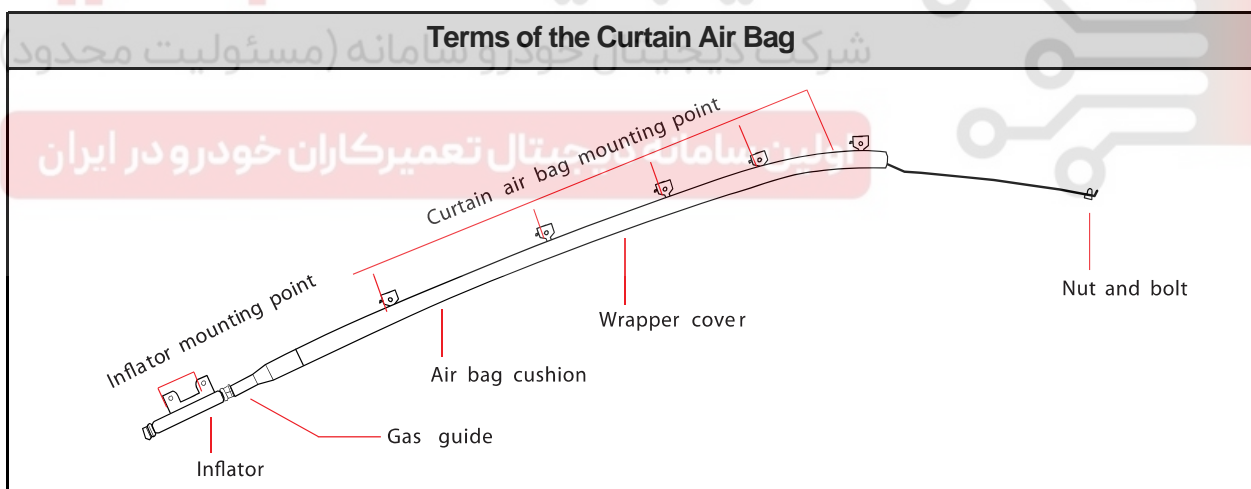

Modification basis	
Application basis	
Affected VIN	021 62 99 92 92

(1) Components

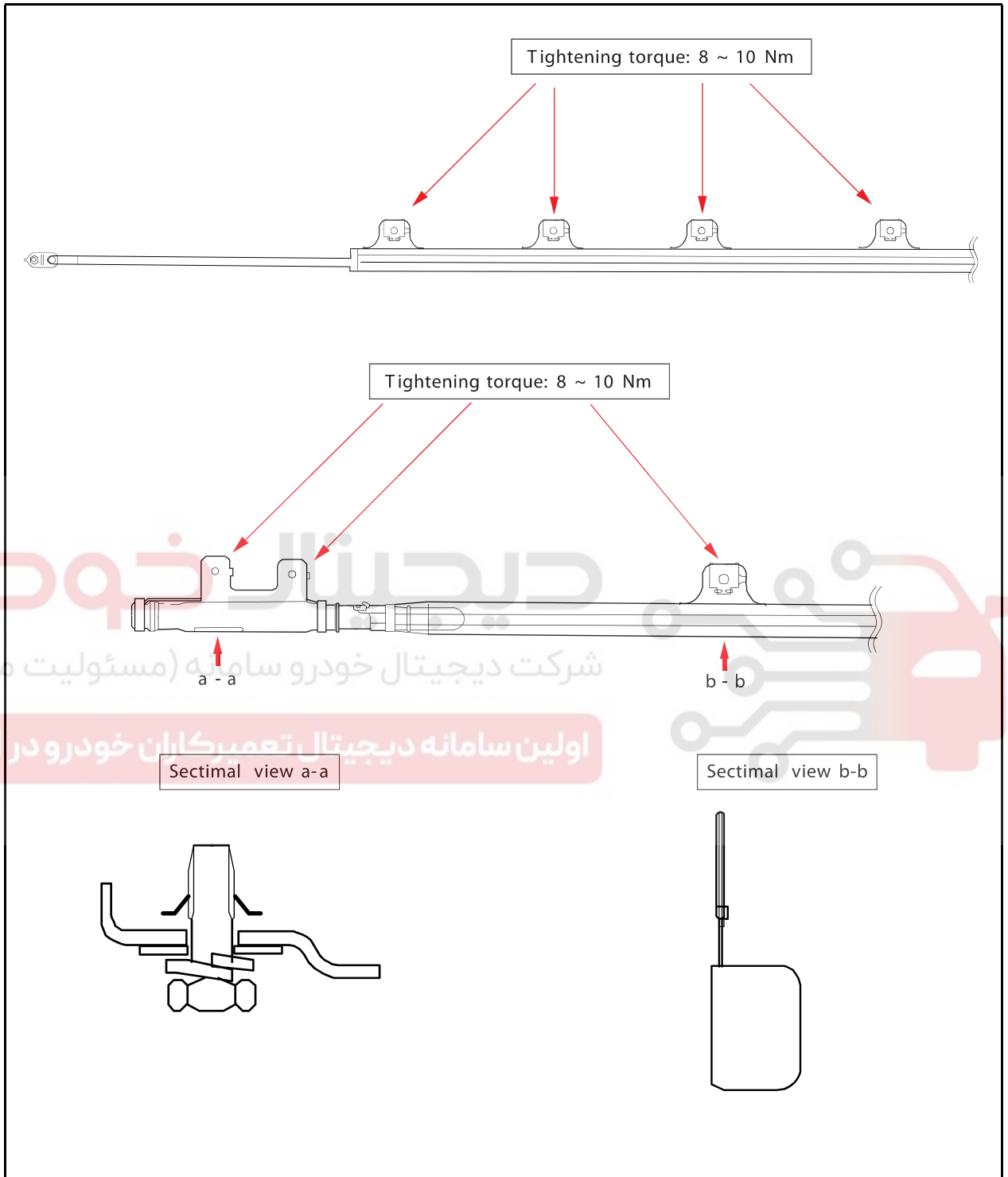

AIR CONDITIO  
AIR BAG  
SEAT  
SUNROO  
F  
BODY INTERIOR  
BODY EXTERIO  
BODY REPAIR

Modification basis	
Application basis	
Allocated VIN	

#### 4) Driver and Passenger BPT (Belt Pre-Tensioner)

The belt pretensioner is installed at the lower side of the B-pillar and operates simultaneously when the front air bags deploy. When a collision occurs or when brakes are applied, a seat belt with a pretensioner detects the stopping action and tightens the belt before the wearer is propelled forward. This holds the occupant more securely in the seat.



Modification basis	
Application basis	
Affected VIN	021 62 99 92 92

(1) Components

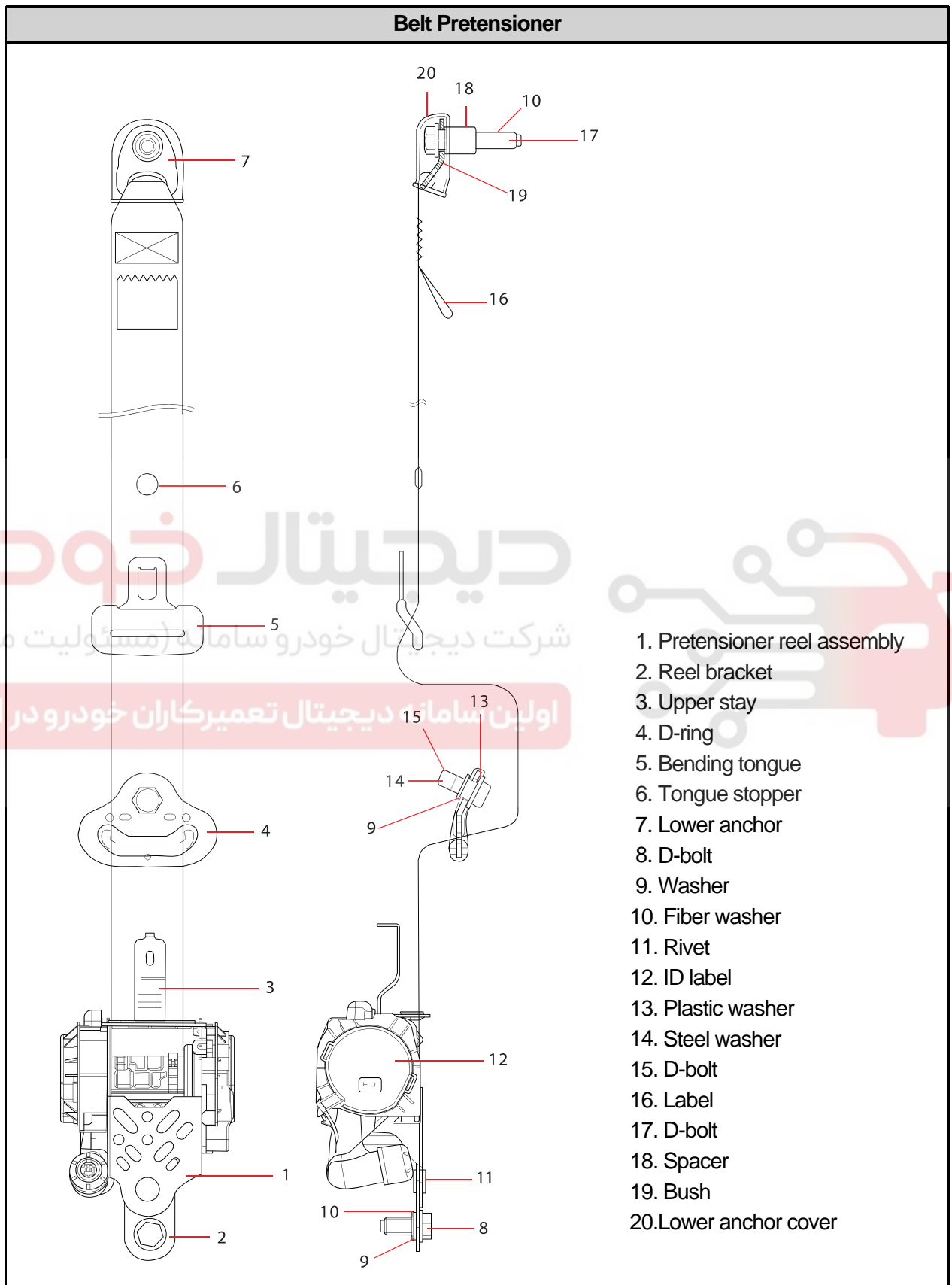

AIR CONDITIO  
 AIR BAG  
 SEAT  
 SUNROO  
 F  
 BODY  
 INTERIOR  
 BODY  
 EXTERIO  
 BODY  
 REPAIR

دیجیتال خودرو  
 شرکت دیجیتال خودرو سامانه (مسئولیت محدود)  
 اولین سامانه دیجیتال تعمیرکاران خودرو در ایران

Modification basis	
Application basis	
Allocated VIN	

### 5) Air Bag Unit



**CAUTION** Air bag unit is installed under the AV head unit in center fascia panel.

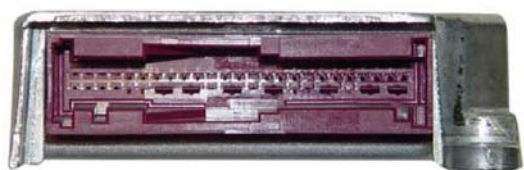

The sensor that detects collision is integrated into the air bag unit.

Air Bag Unit	Connector
	

Modification basis	
Application basis	
Affected VIN	021 62 99 92 92

### 6) Curtain Air Bag Sensor

The curtain air bag sensor is installed inside each B-pillar of the driver's and passenger's seats (that is, around the pretensioner reel). The body panel has guiding holes to ensure its correct installation. But incorrect tightening torque may break the sensor or make it insecure. As a result, the sensor may have inaccurate judgment and have the air bag deployed inaccurately.

Driver's Side

Passenger's Side



Tightening torque 9 Nm ± 1 Nm



#### Connector

Signal terminal

Ground

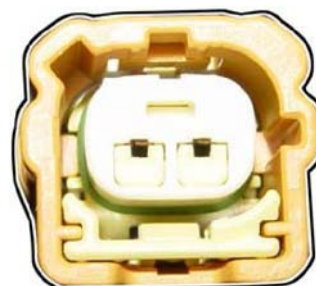

Modification basis	
Application basis	
Allocated VIN	

AIR BAG

ACTYON 2013.11

## 7) Air Bag System Deployment (Firing Loop)

According to the collision deceleration rate that each collision G sensor reads, the air bag unit sends out about 2~4 or higher Amp current. This current generates some heat, which fires the detonator in the inflator.

This table shows the basic inner resistance of the air bag related module and the basic instant current necessary for firing.

Air bag module	Driver/passenger air bag (DAB / PAB)	Belt pretensioner (BPT )	Curtain air bag (CAB)
Resistance (at -30 ~ 85°C)	2 ± 0.3 Ω	2.15 ± 0.35 Ω	2 ± 0.3 Ω
Firing current	1.2 Amp	0.8 Amp	1.0 Amp

### ⚠ CAUTION

- Please do not connect a tester to any air bag connector or single item to measure the supplied power or resistance. The detonator may explode due to a sudden extra power supplied by the tester.
- Before removing or installing any air bag related components, disconnect the negative battery cable.

شرکت دیجیتال خودرو (مسئولیت محدود)

اولین سامانه دیجیتال تعمیرکاران خودرو در ایران

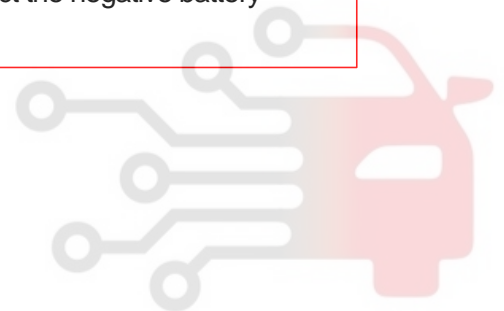



### 8) Air Bag Deployment Signal Output (Crash Out)

When the air bag deploys, the signal is sent to STICS to perform the basic security operation which is the automatic door unlock function that release the automatic door lock mode.

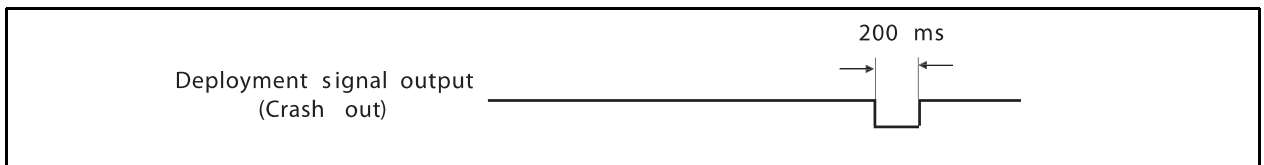

#### (1) Automatic Door Unlock (Crash unlock: unlock when colliding)

1. When the ignition key is the ON position, the air bag signal is not accepted for the first 7 seconds. When the ignition key is the ON position and the vehicle speed is 3 km/h or higher, 40 ms after receiving the air bag deployment signal, the STICS sends out the door UNLOCK signal for 5 seconds. Even though the ignition switch is turned off in the middle of the unlock signal being sent out, the unlock signal continues for the remaining time.
2. This function cancels when the ignition key is withdrawn.
- 3.
- 4.

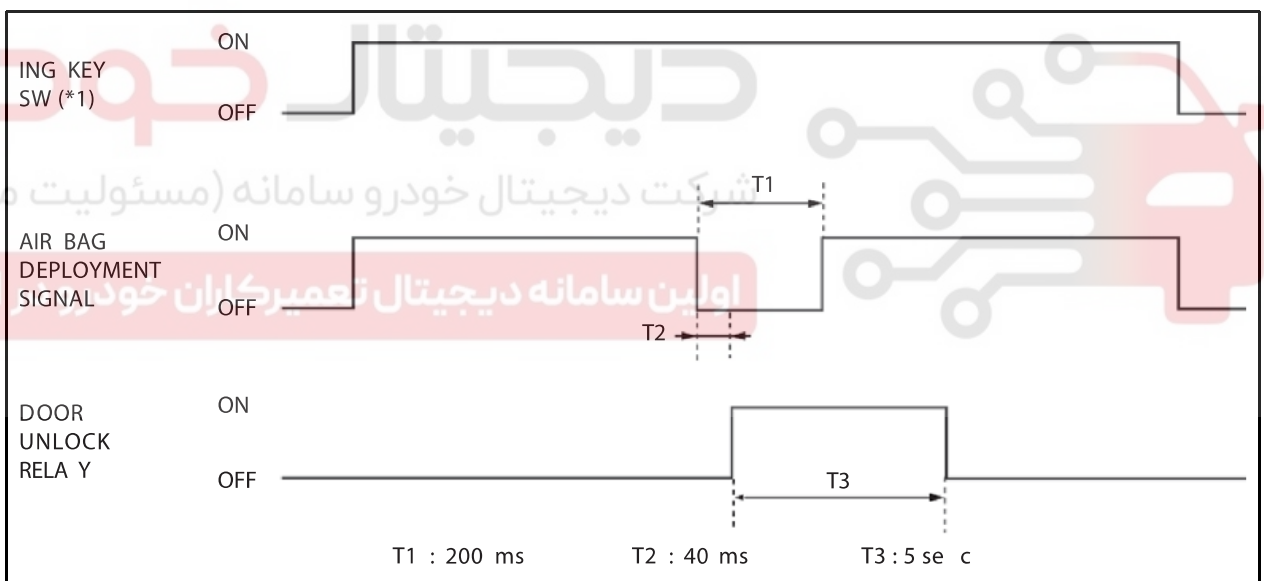

**CAUTION**

Reminder for door lock/unlock control

- The unlock function by the air bag signal takes priority over any other lock/unlock operations. While or after the automatic unlock is made by the air bag system, any lock or unlock request by other functions is ignored unless the ignition key switch is turned off.
- When another lock or unlock output is requested while the door is being either locked or unlock, the new request will be ignored. But, if an unlock request is made by the air bag signal or the remote control key, the request will be accepted.
- When the lock and unlock functions are simultaneously requested, the lock function will be performed and the unlock function will be ignored.

Modification basis	
Application basis	
Allocated VIN	

AIR CONDITIONING  
 AIR BAG  
 SEAT  
 SUNROOF  
 BODY INTERIOR  
 BODY EXTERIOR  
 BODY REPAIR

### 9) Air Bag Warning Lamp Operational Conditions

The air bag warning lamp on the instrument panel has a few operational conditions. The following are the conditions:

#### (1) When Turning the Ignition Switch to ON Position

The air bag unit performs a turn-on test when the ignition is turned on. The air bag unit flashes the air bag warning lamp six times at 1Hz interval. After flashing it six times, the air bag warning lamp will turn off if no malfunction have been detected.

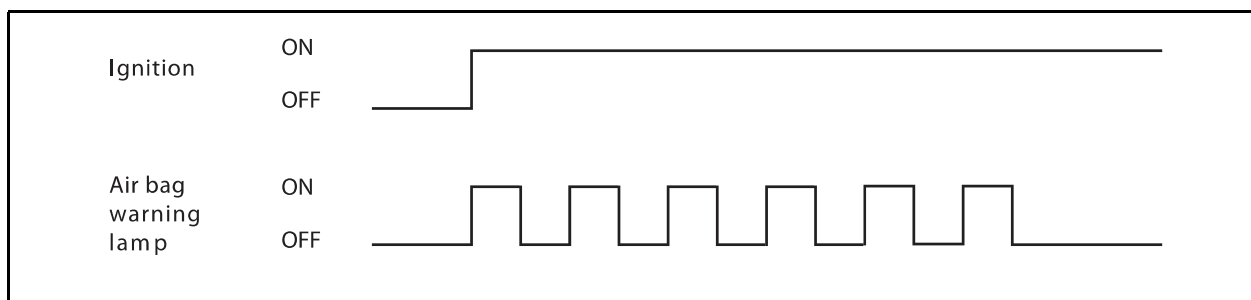

#### (2) When the Air Bag Unit Detects Any Malfunctions in Unit

When it is recorded as a system failure in the air bag unit, the air bag warning lamp on the instrument panel comes on for about 6 seconds and goes off for 1 second. Then the warning lamp stays on.

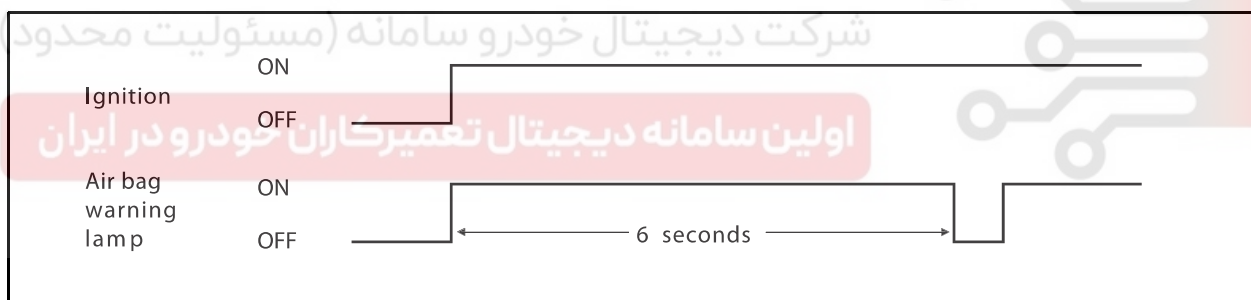

#### (3) When the Air Bag Unit Receives Any Malfunction Signals from the Other Systems

When, due to an error from outside the system, the intermittent failure signal is received 5 times or less, the air bag warning lamp comes on for about 6 seconds and then, goes off.

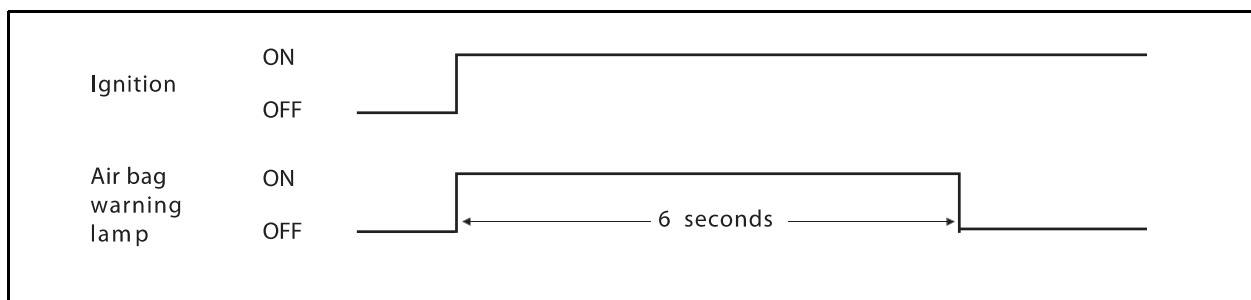

Modification basis	
Application basis	
Affected VIN	021 62 99 92 92

### 10) Electrical Wiring Diagram

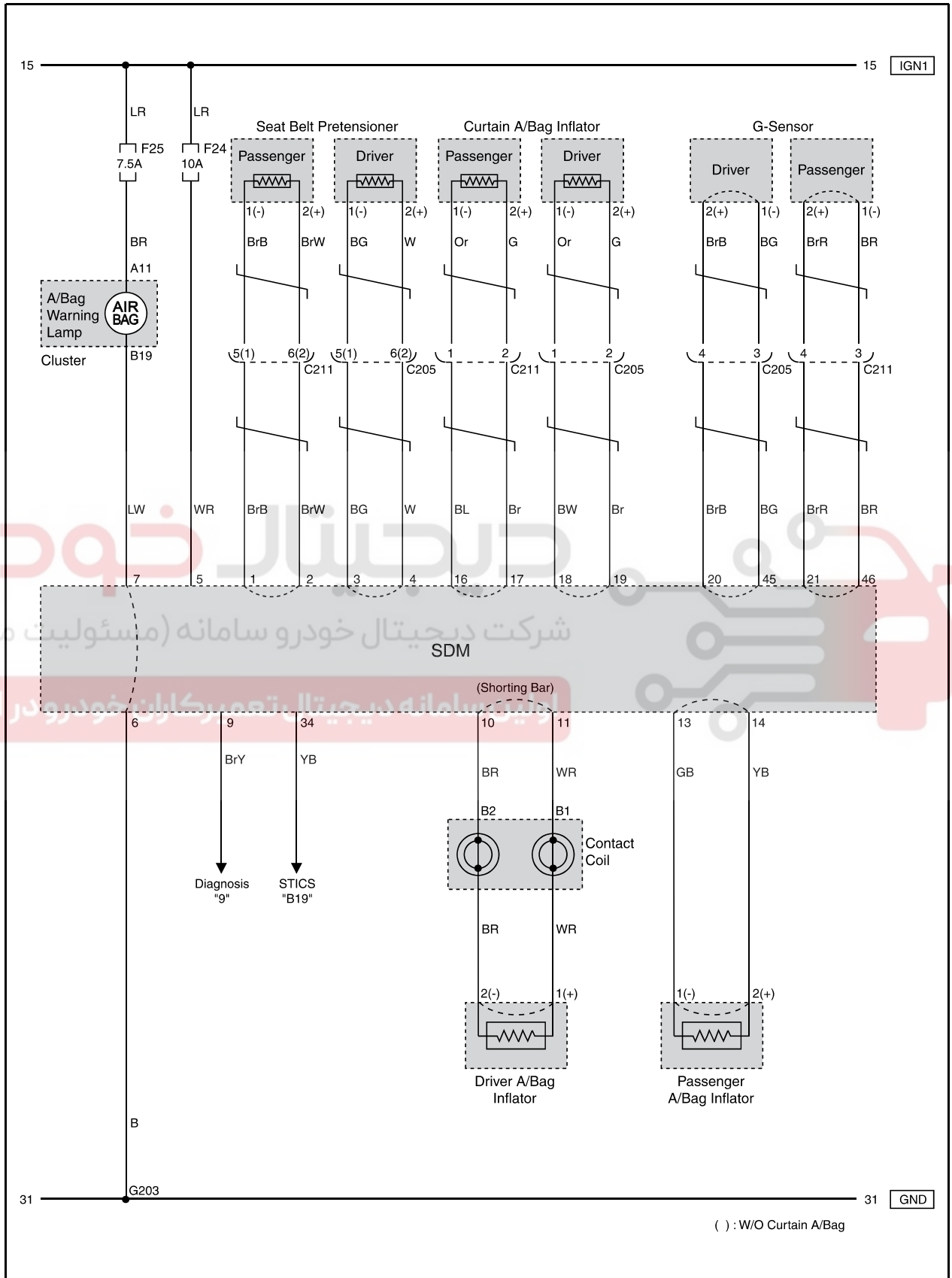

AIR CONDITIO  
 AIR BAG  
 SEAT  
 SUNROO F  
 BODY INTERIOR  
 BODY EXTERIO  
 BODY REPAIR



Modification basis	
Application basis	
Allocated VIN	

REMOVAL AND INSTALLATION

8810-03 TROUBLE

Trouble Code	Defections	Action
1101	High battery voltage	<ul style="list-style-type: none"> <li>• Check alternator output voltage.</li> <li>• Check battery condition (if its voltage is over 21.4 V for 16 seconds).</li> <li>• Check air bag unit terminals for damage.</li> </ul>
1102	Low battery voltage	<ul style="list-style-type: none"> <li>• Check alternator output voltage.</li> <li>• Check battery condition (if its voltage is below 7.2 V for 16 seconds, the warning lamp comes on. It resumes when the voltage is normal level for 9.6 seconds )</li> <li>• Check air bag unit terminals for damage.</li> </ul>
1103	Low communication voltage for curtain air bag sensor	<ul style="list-style-type: none"> <li>• Check curtain air bag sensor connector.</li> <li>• Check curtain air bag sensor wiring.</li> <li>• Check air bag unit terminals for damage.</li> <li>• Check if curtain air bag sensor is short to battery voltage or ground.</li> <li>• Check if curtain air bag sensor is defective.</li> <li>• Check battery condition (if its voltage is below 10.6 V for 16 seconds, the warning lamp comes on. It resumes when the voltage is normal level for 9.6 seconds).</li> </ul>
1346	Driver's air bag circuit resistance is too high	<ul style="list-style-type: none"> <li>• Check driver air bag connector.</li> <li>• Check driver air bag wiring (including clock spring).</li> <li>• Check air bag unit terminals for damage.</li> <li>• Resistance of squib: over 6.1 Ω</li> </ul>
1347	Driver's air bag circuit resistance is too low	<ul style="list-style-type: none"> <li>• Check driver air bag connector.</li> <li>• Check driver air bag connector (including clock spring).</li> <li>• Check air bag unit terminals for damage.</li> <li>• Resistance of squib: below 1.1 Ω</li> </ul>
1348	Driver's air bag circuit is short to ground	<ul style="list-style-type: none"> <li>• Check driver air bag connector.</li> <li>• Check driver air bag wiring (including clock spring).</li> <li>• Check air bag unit terminals for damage.</li> <li>• Resistance of Firing Loop: below 2 kΩ</li> </ul>
1349	Drivers air bag circuit is short to battery voltage	<ul style="list-style-type: none"> <li>• Check driver air bag connector.</li> <li>• Check driver air bag wiring (including clock spring).</li> <li>• Check the air bag unit terminals for damage.</li> <li>• Resistance of Firing Loop: below 2 kΩ</li> </ul>
1352	Passengers air bag circuit resistance is too high	<ul style="list-style-type: none"> <li>• Check passenger air bag connector.</li> <li>• Check passenger air bag wiring.</li> <li>• Check the air bag unit terminals for damage.</li> <li>• Resistance of squib: below 4.0 Ω</li> </ul>
1353	Passengers air bag circuit resistance is too low	<ul style="list-style-type: none"> <li>• Check passenger air bag connector.</li> <li>• Check passenger air bag wiring.</li> <li>• Check air bag unit terminals for damage.</li> <li>• Resistance of squib: over 0.8 Ω</li> </ul>
1354	Passengers air bag circuit is short to ground	<ul style="list-style-type: none"> <li>• Check passenger air bag connector.</li> <li>• Check passenger air bag wiring.</li> <li>• Check the air bag unit terminals for damage.</li> <li>• Resistance of Firing Loop: below 2 kΩ</li> </ul>

Modification basis	
Application basis	
Affected VIN	021 62 99 92 92

Trouble Code	Defections	Action
1355	Passenger's air bag circuit is short to battery voltage	<ul style="list-style-type: none"> <li>• Check passenger air bag connector.</li> <li>• Check passenger air bag wiring.</li> <li>• Check air bag unit terminals for damage.</li> <li>• Resistance of Firing Loop: below 2 kΩ</li> </ul>
1361	Driver's pretensioner circuit resistance is too high	<ul style="list-style-type: none"> <li>• Check driver pretensioner connector.</li> <li>• Check driver pretensioner wiring.</li> <li>• Check air bag unit terminals for damage.</li> <li>• Resistance of squib: over 4.2 Ω</li> </ul>
1362	Driver's pretensioner circuit resistance is too low	<ul style="list-style-type: none"> <li>• Check driver pretensioner connector.</li> <li>• Check driver pretensioner wiring.</li> <li>• Check air bag unit terminals for damage.</li> <li>• Resistance of squib: below 0.8 Ω</li> </ul>
1363	Driver's pretensioner circuit is short to ground	<ul style="list-style-type: none"> <li>• Check driver pretensioner connector.</li> <li>• Check driver pretensioner wiring.</li> <li>• Check air bag unit terminals for damage.</li> <li>• Resistance of Firing Loop: below 2 kΩ</li> </ul>
1364	Driver's pretensioner circuit is short to battery voltage	<ul style="list-style-type: none"> <li>• Check driver pretensioner connector.</li> <li>• Check driver pretensioner wiring.</li> <li>• Check air bag unit terminals for damage.</li> <li>• Resistance of Firing Loop: below 2 kΩ</li> </ul>
1367	Passenger's pretensioner circuit resistance is too high	<ul style="list-style-type: none"> <li>• Check passenger pretensioner connector.</li> <li>• Check passenger pretensioner wiring.</li> <li>• Check air bag unit terminals for damage.</li> <li>• Resistance of squib: over 4.2 Ω</li> </ul>
1368	Passenger's pretensioner circuit resistance is too low	<ul style="list-style-type: none"> <li>• Check passenger pretensioner connector.</li> <li>• Check passenger pretensioner wiring.</li> <li>• Check air bag unit terminals for damage.</li> <li>• Resistance of squib: below 0.8 Ω</li> </ul>
1369	Passenger's pretensioner circuit is short to ground	<ul style="list-style-type: none"> <li>• Check passenger pretensioner connector.</li> <li>• Check passenger pretensioner wiring.</li> <li>• Check air bag unit terminals for damage.</li> <li>• Resistance of Firing Loop: below 2 kΩ</li> </ul>
1370	Passenger's pretensioner circuit is short to battery voltage	<ul style="list-style-type: none"> <li>• Check passenger pretensioner connector.</li> <li>• Check passenger pretensioner wiring.</li> <li>• Check air bag unit terminals for damage.</li> <li>• Resistance of Firing Loop: below 2 kΩ</li> </ul>
1378	Driver's curtain air bag circuit resistance is too high	<ul style="list-style-type: none"> <li>• Check driver curtain air bag connector.</li> <li>• Check driver curtain air bag wiring.</li> <li>• Check the air bag unit terminals for damage.</li> <li>• Resistance of squib: over 4.3 Ω</li> </ul>
1379	Driver's curtain air bag circuit resistance is too low	<ul style="list-style-type: none"> <li>• Check driver curtain air bag connector.</li> <li>• Check driver curtain air bag wiring.</li> <li>• Check the air bag unit terminals for damage.</li> <li>• Resistance of squib: below 0.6 Ω</li> </ul>

AIR CONDITION  
AIR BAG  
SEAT  
SUNROOF  
BODY INTERIOR  
BODY EXTERIOR  
BODY REPAIR

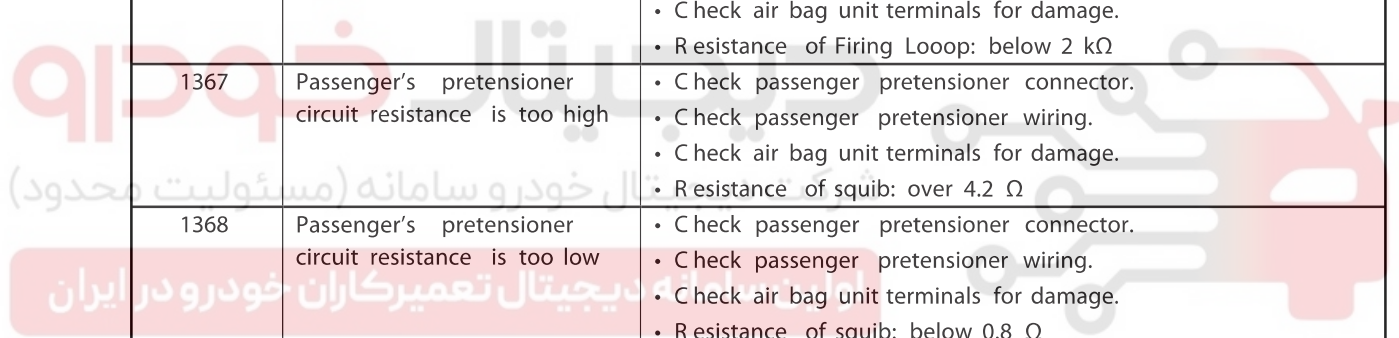

Modification basis	
Application basis	
Allocated VIN	

Trouble Code	Defections	Action
1380	Driver's curtain air bag is short to ground	<ul style="list-style-type: none"> <li>• Check driver curtain air bag connector.</li> <li>• Check driver curtain air bag wiring.</li> <li>• Check air bag unit terminals for damage.</li> <li>• Resistance: below 2 kΩ</li> </ul>
1381	Driver's curtain air bag is short to battery voltage	<ul style="list-style-type: none"> <li>• Check driver curtain air bag connector.</li> <li>• Check driver curtain air bag wiring.</li> <li>• Check air bag unit terminals for damage.</li> <li>• Resistance: below 2 kΩ</li> </ul>
1382	Passenger's curtain air bag circuit resistance is too high	<ul style="list-style-type: none"> <li>• Check passenger curtain air bag connector.</li> <li>• Check passenger curtain air bag wiring.</li> <li>• Check air bag unit terminals for damage.</li> <li>• Resistance of squib: over 4.3 Ω</li> </ul>
1383	Passenger's curtain air bag circuit resistance is too low	<ul style="list-style-type: none"> <li>• Check passenger curtain air bag connector.</li> <li>• Check passenger curtain air bag wiring.</li> <li>• Check air bag unit terminals for damage.</li> <li>• Resistance of squib: below 0.6 Ω</li> </ul>
1384	Passenger's curtain air bag is short to ground	<ul style="list-style-type: none"> <li>• Check passenger curtain air bag connector.</li> <li>• Check passenger curtain air bag wiring.</li> <li>• Check air bag unit terminals for damage.</li> <li>• Resistance: below 2 kΩ</li> </ul>
1385	Passenger's curtain air bag is short to battery voltage	<ul style="list-style-type: none"> <li>• Check passenger curtain air bag connector.</li> <li>• Check passenger curtain air bag wiring.</li> <li>• Check air bag unit terminals for damage.</li> <li>• Resistance: below 2 kΩ</li> </ul>
1395	Air bag connector problem	<ul style="list-style-type: none"> <li>• Check passenger curtain air bag connector.</li> <li>• Check passenger curtain air bag wiring.</li> <li>• Check air bag unit terminals for damage.</li> </ul>
1400	Driver's curtain air bag sensor problem	<ul style="list-style-type: none"> <li>• Check driver curtain air bag sensor connector.</li> <li>• Check driver curtain air bag sensor wiring.</li> <li>• Check air bag unit terminals for damage.</li> </ul>
1401	Driver's curtain air bag sensor circuit is short to ground	<ul style="list-style-type: none"> <li>• Check driver curtain air bag sensor connector.</li> <li>• Check driver curtain air bag sensor wiring.</li> <li>• Check the air bag unit terminals for damage.</li> <li>• Resistance: below 250 Ω</li> </ul>
1402	Driver's curtain air bag sensor circuit is short to battery voltage	<ul style="list-style-type: none"> <li>• Check driver curtain air bag sensor connector.</li> <li>• Check driver curtain air bag sensor wiring.</li> <li>• Check air bag unit terminals for damage.</li> <li>• Resistance: below 25 Ω</li> </ul>
1409	Communication error in driver's curtain air bag sensor	<ul style="list-style-type: none"> <li>• Check driver curtain air bag sensor connector.</li> <li>• Check driver curtain air bag sensor wiring.</li> <li>• Check air bag unit terminals for damage.</li> <li>• If the voltage drops below 10.6 V during normal system operation, the trouble code is generated. This trouble code is linked with B1 400, B1 401, B1 402 and B1 414.</li> </ul>

AIR BAG

ACTYON 2013.11

Modification basis	
Application basis	
Affected VIN	021 62 99 92 92

Trouble Code	Defections	Actio n
1414	Wrong driver's curtain air bag sensor	<ul style="list-style-type: none"> <li>• C heck driver curtain air bag sensor connector.</li> <li>• C heck driver curtain air bag sensor wiring.</li> <li>• C heck air bag unit terminals for damage.</li> </ul>
1403	Defective passenger's curtain air bag sensor	<ul style="list-style-type: none"> <li>• C heck passenger curtain air bag sensor connector.</li> <li>• C heck passenger curtain air bag sensor wiring.</li> <li>• C heck air bag unit terminals for damage.</li> </ul>
1404	Passenger's curtain air bag sensor circuit is short to ground	<ul style="list-style-type: none"> <li>• C heck passenger curtain air bag sensor connector.</li> <li>• C heck passenger curtain air bag sensor wiring.</li> <li>• C heck air bag unit terminals for damage.</li> <li>• R esistance: below 250 Ω</li> </ul>
1405	Passenger's curtain air bag sensor circuit is short to battery voltage	<ul style="list-style-type: none"> <li>• C heck passenger curtain air bag sensor connector.</li> <li>• C heck passenger curtain air bag sensor wiring.</li> <li>• C heck air bag unit terminals for damage.</li> <li>• R esistance: below 25 Ω</li> </ul>
1410	Communication error in passenger's curtain air bag sensor	<ul style="list-style-type: none"> <li>• C heck passenger curtain air bag sensor connector.</li> <li>• C heck passenger curtain air bag sensor wiring.</li> <li>• C heck the air bag unit terminals for damage.</li> <li>• I f the voltage drops below 10.6 V during normal system operation, the trouble code is generated. This trouble code is linked with B1 403, B1 404, B1 405 and B1 415.</li> </ul>
1415	Wrong driver's curtain air bag sensor	<ul style="list-style-type: none"> <li>• C heck passenger curtain air bag sensor connector.</li> <li>• C heck passenger curtain air bag sensor wiring.</li> <li>• C heck air bag unit terminals for damage.</li> </ul>
1620	SDM internal fault	<ul style="list-style-type: none"> <li>• R eplace SDM.</li> </ul>
1650	Frontal impact record	<ul style="list-style-type: none"> <li>• R eplace SDM.</li> </ul>
1651	Driver's curtain air bag impact record	<ul style="list-style-type: none"> <li>• R eplace SDM.</li> </ul>
1652	Passenger's curtain air bag impact record	<ul style="list-style-type: none"> <li>• R eplace SDM.</li> </ul>
1657	Belt pretensioner operation record	<ul style="list-style-type: none"> <li>• R eplace SDM.</li> </ul>
2500	Warning lamp error	<ul style="list-style-type: none"> <li>• C heck wiring to warning lamp.</li> <li>• C heck warning lamp bulb.</li> <li>• C heck SDM unit terminal for damage.</li> </ul>

AIR CONDITIO  
 AIR BAG  
 SEAT  
 SUNROO F  
 BODY INTERIOR  
 BODY EXTERIO  
 BODY REPAIR

Modification basis	
Application basis	
Allocated VIN	

S.G.N. **8810-03 DRIVER AIR BAG**

**Preceding work** 1. Disconnect the negative battery cable.



1. Remove the air bag module assembly from steering wheel.  
(For details, refer to "Switch" section.)

2. Disconnect all connectors from the removed air bag module and remove the air bag assembly.

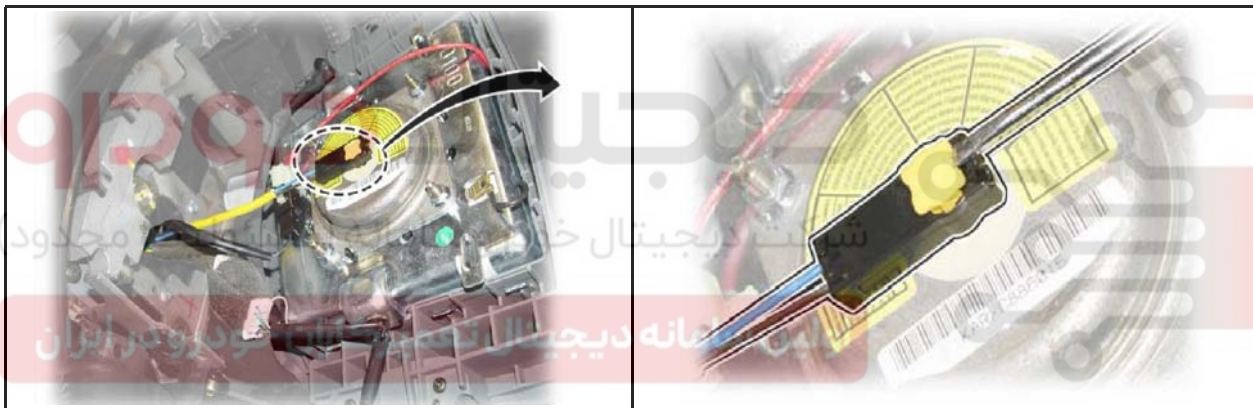

Components	
Front View	Rear View

Modification basis	
Application basis	
Affected VIN	021 62 99 92 92



S.G.N.  
8810-06 PASSENGER AIR BAG

**Preceding work** 1. Disconnect the battery negative cable and remove the instrument panel assembly.  
(For details, refer to "Body" section.)

1. Remove the lower air duct from the removed instrument panel assembly  
(refer to "A/C" section).



2. Unscrew five nuts (10 mm) on the passenger's air bag module.



AIR CONDITIO  
AIR BAG  
SEAT  
SUNROO  
F  
BODY INTERIO  
BODY EXTERIO  
BODY REPAIR

دیجیتال خودرو سامانه دیجیتال تعمیرکاران خودرو در ایران  
شرکت دیجیتال خودرو سامانه دیجیتال (محدود)  
اولین سامانه دیجیتال تعمیرکاران خودرو در ایران

Modification basis	
Application basis	
Allocated VIN	

3. Remove the air bag module assembly from the instrument panel.



**⚠ WARNING**

The air bag module cannot be removed. Below picture is only for reference.

**Components**



Modification basis	
Application basis	
Affected VIN	021 62 99 92 92

S.G.N. **8810-11 CURTAIN AIR BAG**

**Preceding work**

1. Disconnect the negative (-) battery cable.
2. Remove the headlining assembly (refer to "Body" section).

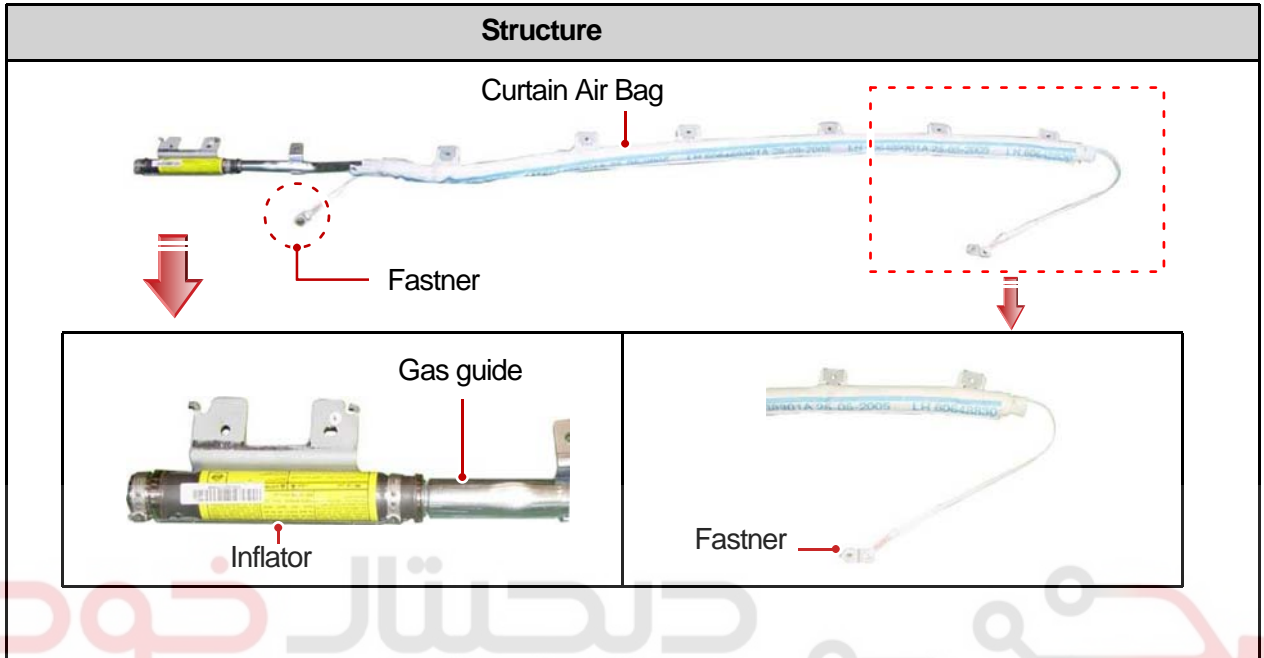

1. Disconnect the connector of the curtain air bag while releasing the hook.

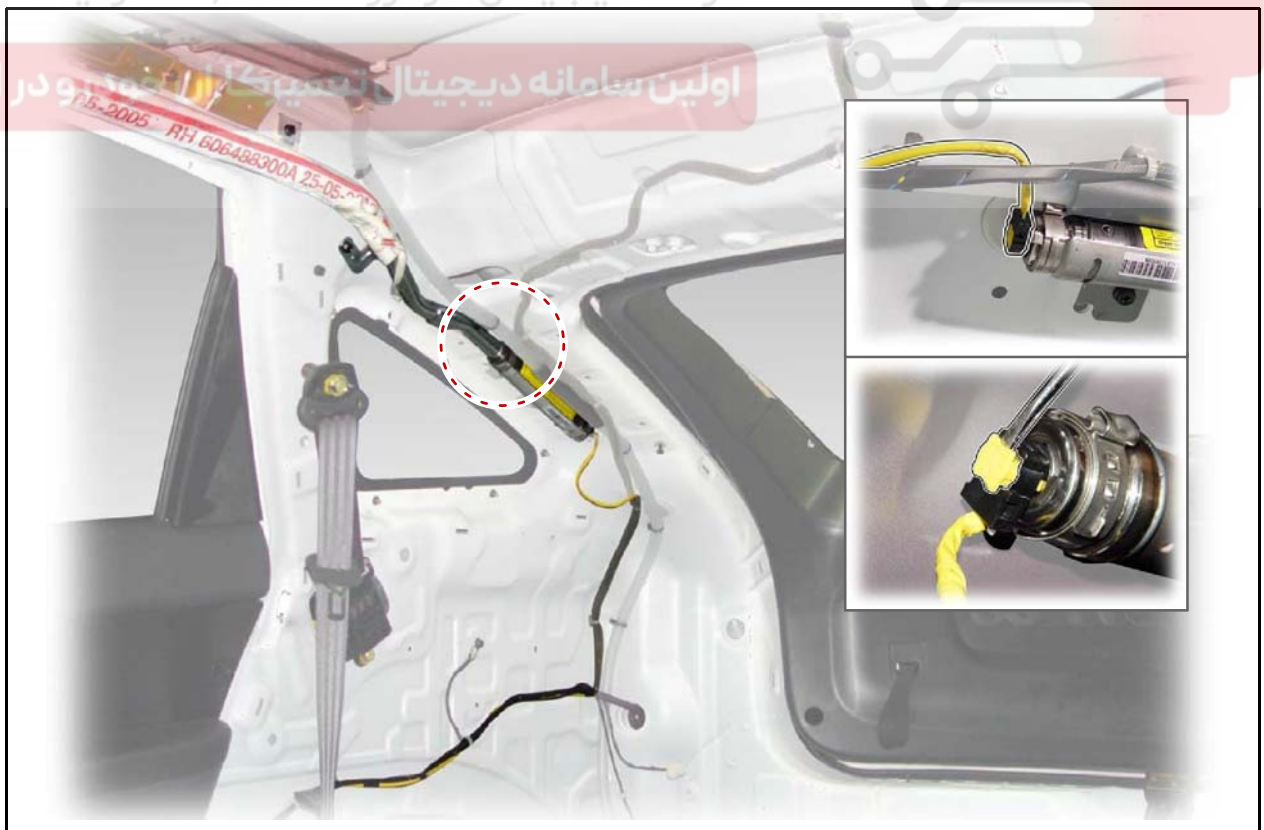

Modification basis	
Application basis	
Allocated VIN	

2. Remove the assist grip (handle) from the roof trim.

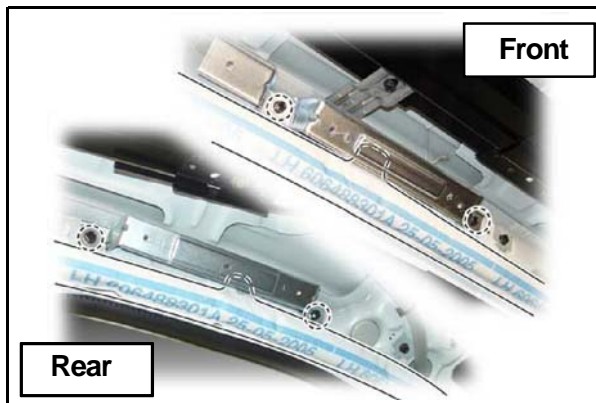

3. Remove the mounting bolt from the front curtain air bag.



4. Unscrew the mounting bolt and remove the curtain air bag assembly.

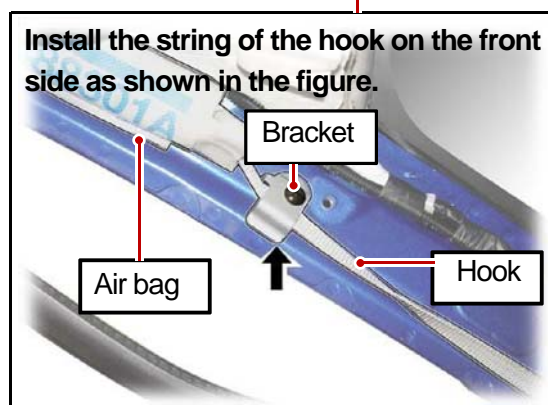
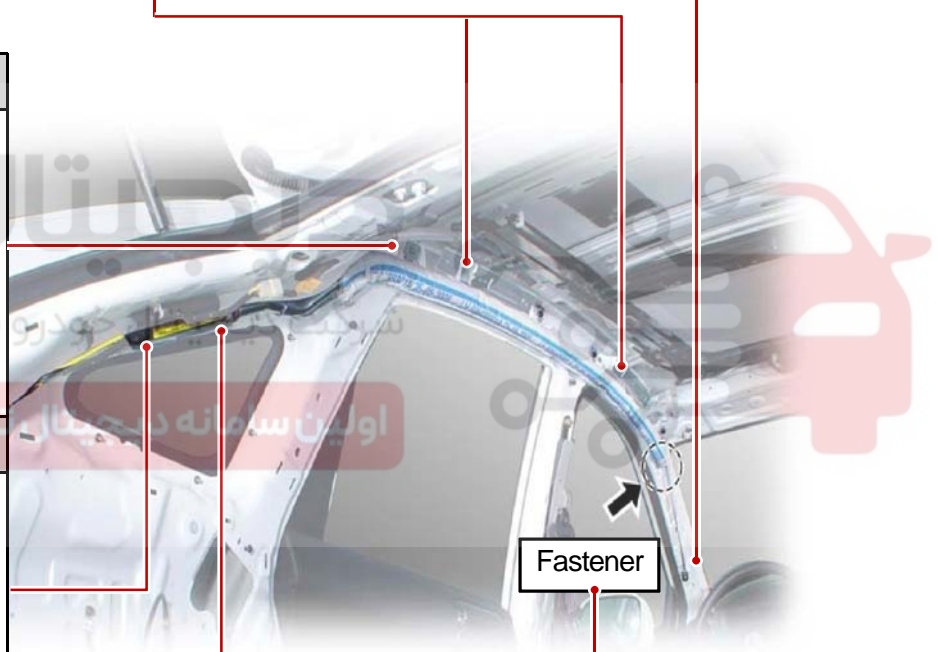
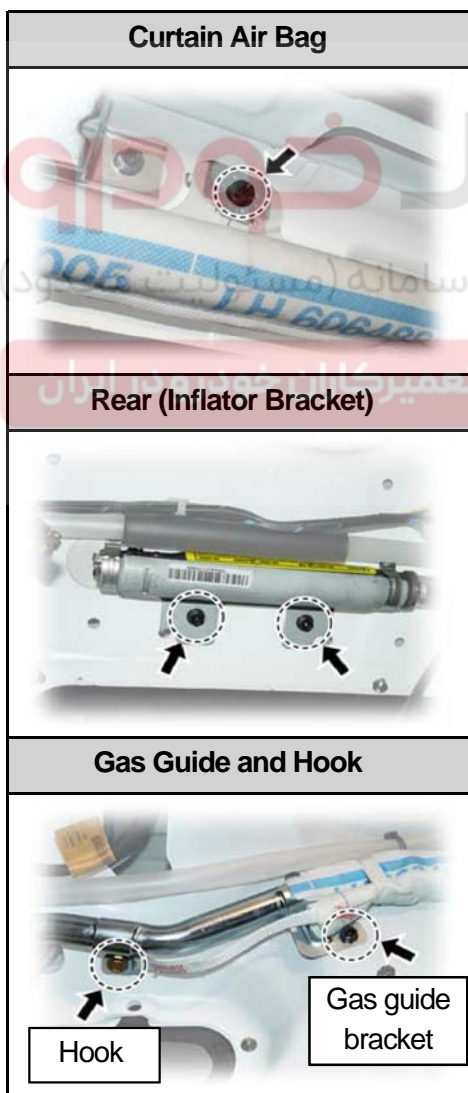

Modification basis	
Application basis	
Affected VIN	021 62 99 92 92

S.G.N.  
8810-12 CONTACT COIL

Preceding work 1. Disconnect the negative battery cable and remove the steering wheel.



1. Disconnect the connector of the contact coil.

2. Unscrew four screws and remove the contact coil.  
Place the contact coil at the center position when installing.

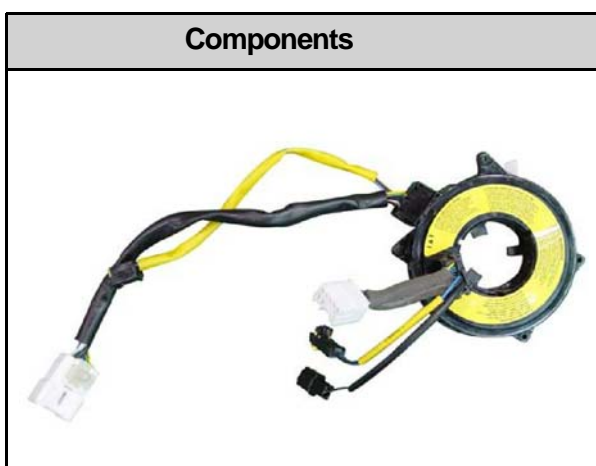
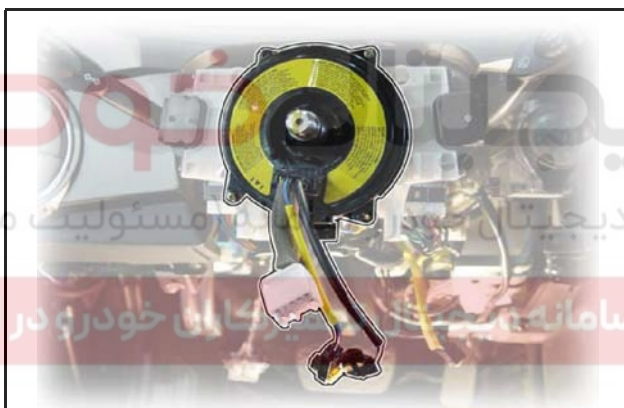

**⚠ CAUTION**

- If the contact coil is not properly aligned, the steering wheel may not be able to rotate completely during turning. Restricted turning ability may cause the vehicle to crash and prevent the air bags from deploying during a crash.
- Turn the contact coil clockwise until it stops and turn it counterclockwise approx.  $2.9 \pm 0.2$  turns to align the "▶◀" marks.

Modification basis	
Application basis	
Allocated VIN	

S.G.N. **8810-01 AIR BAG UNIT(SDM)**

**Preceding work** 1. Disconnect the negative battery cable.

1. Remove the center fascia, lower panels and center console in turns (refer to "Body" section).

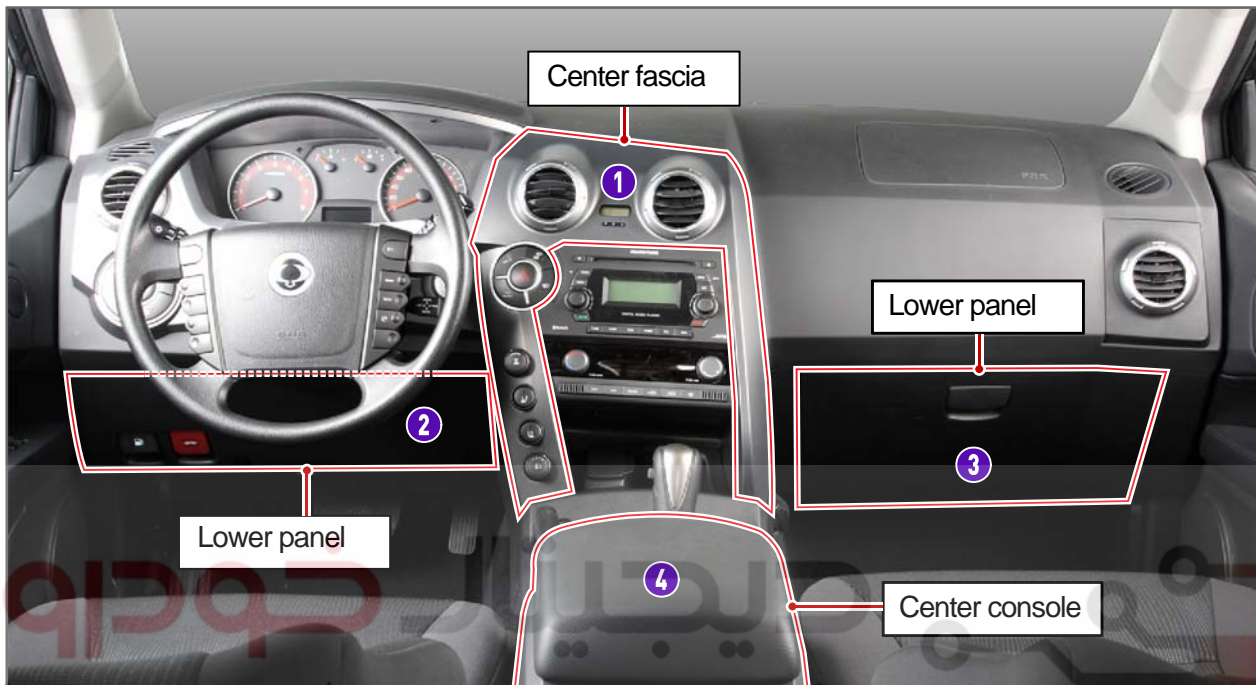

شرکت دیجیتال خودرو سامانه (مستولیت محدود)

2. Remove the head unit (audio and A/C controller) and the lower center instrument panel (refer to "Body" section).

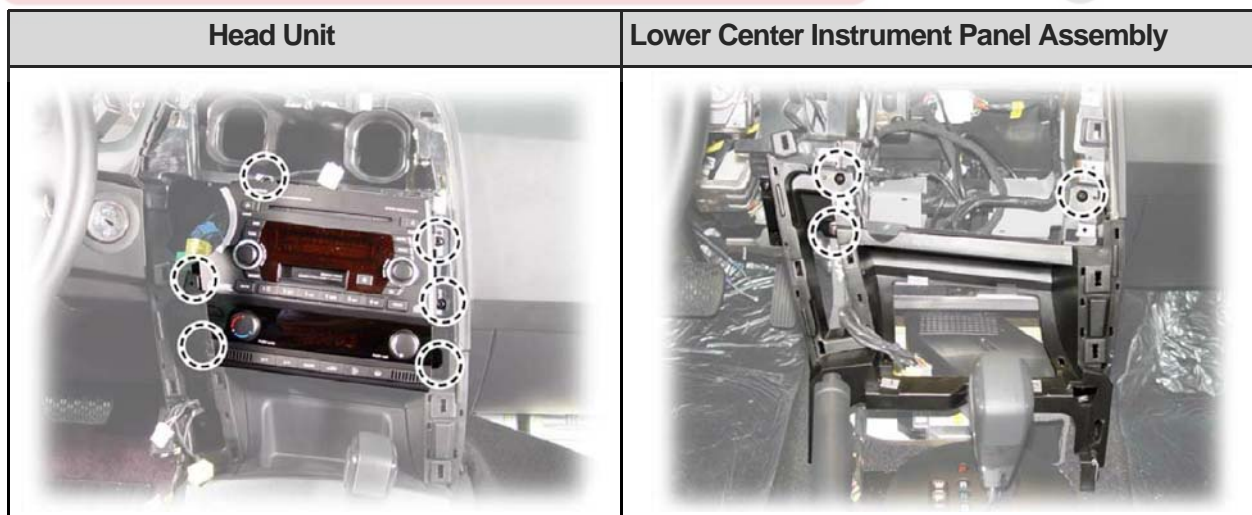

Modification basis	
Application basis	
Affected VIN	021 62 99 92 92

3. Unscrew two screws and remove the air duct.

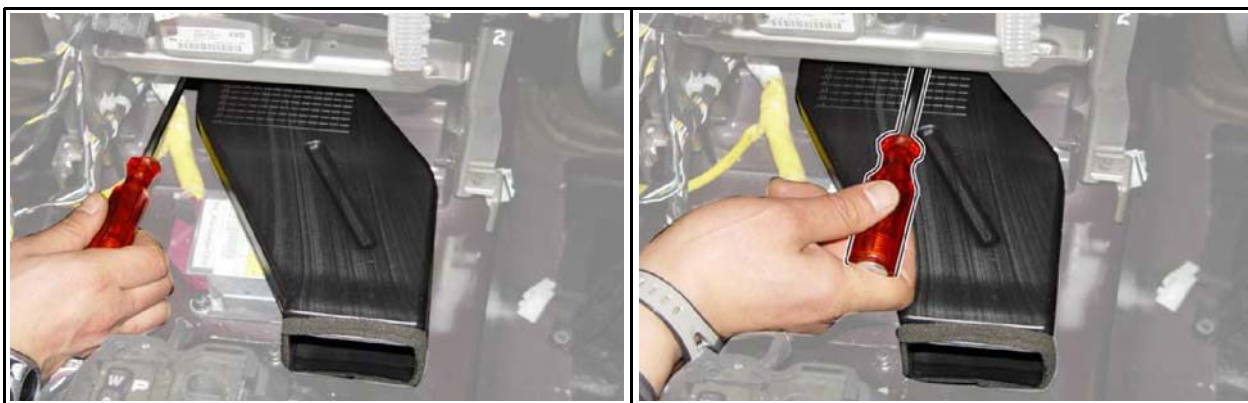

4. Disconnect the connector and remove three mounting nuts to remove the air bag unit.

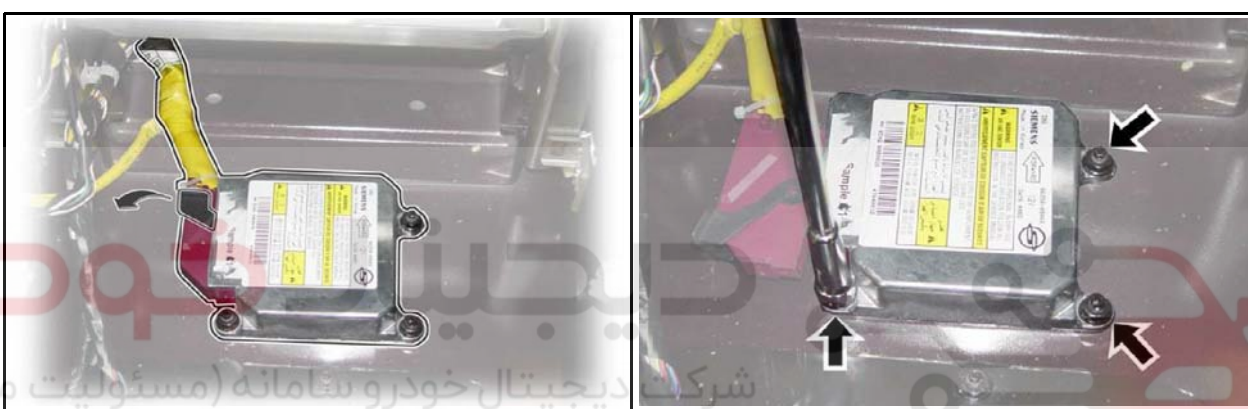

**Components**



**CAUTION**

- When an air bag deploys (curtain air bags and seat belt pretensioners Included), the air bag unit must be replaced. Please do not attempt to delete the failure code with scan - I because some data about the deployment situation are stored in the unit.
- The air bag related components, especially the air bag unit, must be stored in a sealed case to prevent any damage. Please do not connect a tester to any air bag connector or single item to measure the supplied power or resistance. The detonator may explode due to a sudden extra power supplied by the tester.
- Before removing or installing any air bag related components, disconnect the negative battery cable.

Modification basis	
Application basis	
Allocated VIN	

S.G.N.  
8810-16

CURTAIN AIR BAG G SENSOR

Preceding work

1. Disconnect the negative battery cable.

Driver's Side

Passenger's Side

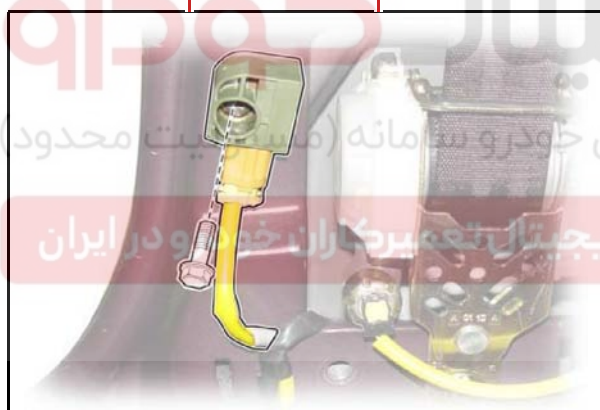



1. Remove the B-pillar panel at both sides. Disconnect the connector and remove one mounting bolt (10 mm) to remove the G sensor.

**Tightening torque** 9 Nm ± 1 Nm

**CAUTION**

- The body panel has guiding holes to ensure its correction installation. But incorrect tightening torque may break the sensor or make it insecure. As a result, the sensor may have inaccurate judgment and have the air bag deployed inaccurately. Because the gap between the installation bolt and the sensor is small, grind the bolt-locking socket to around 1.5 mm before mounting the curtain air bag sensor fixation bolt.

Components

	
---	--

Modification basis	
Application basis	
Affected VIN	021 62 99 92 92