

20 MOT

Engineering Office

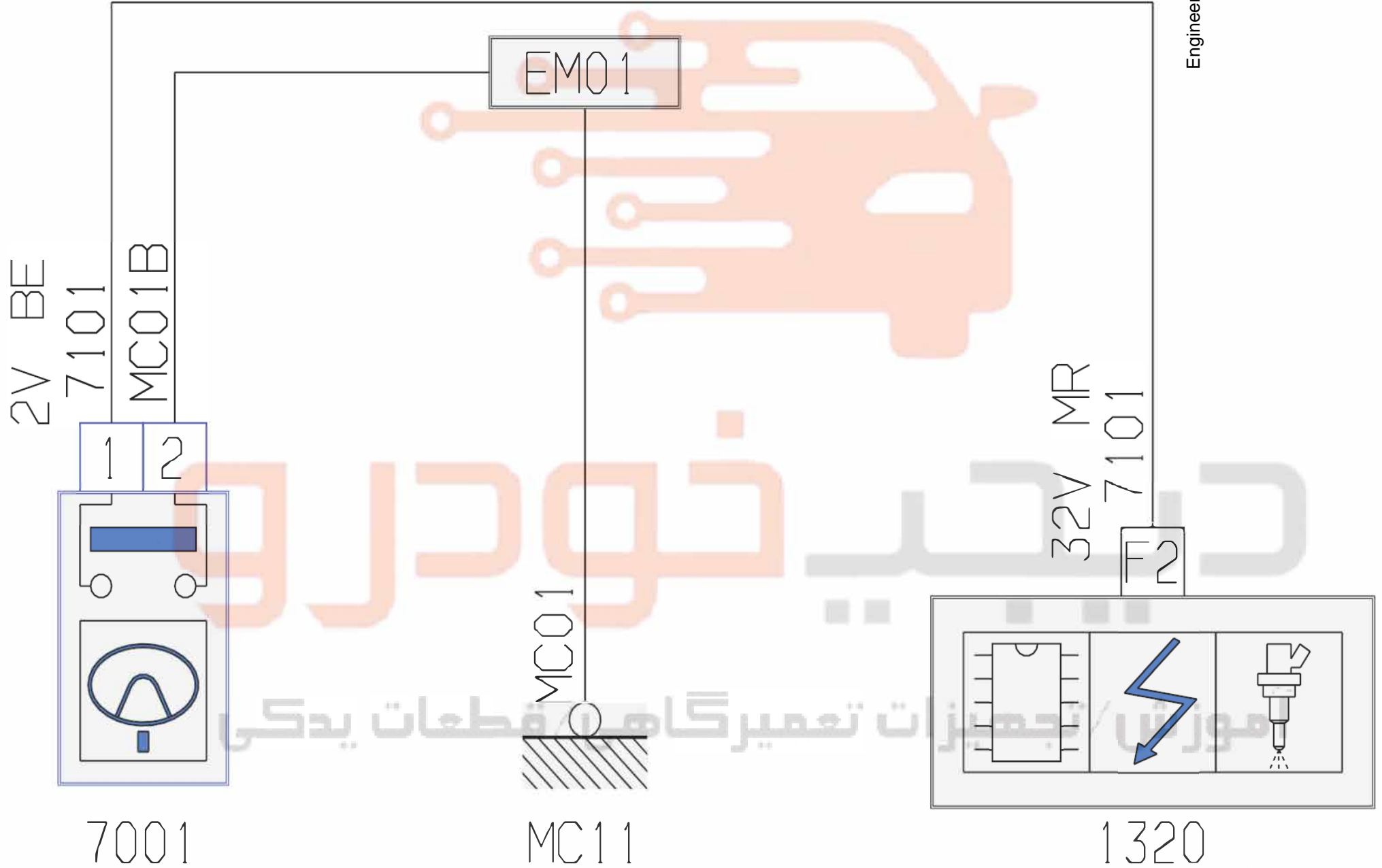

20 MOT

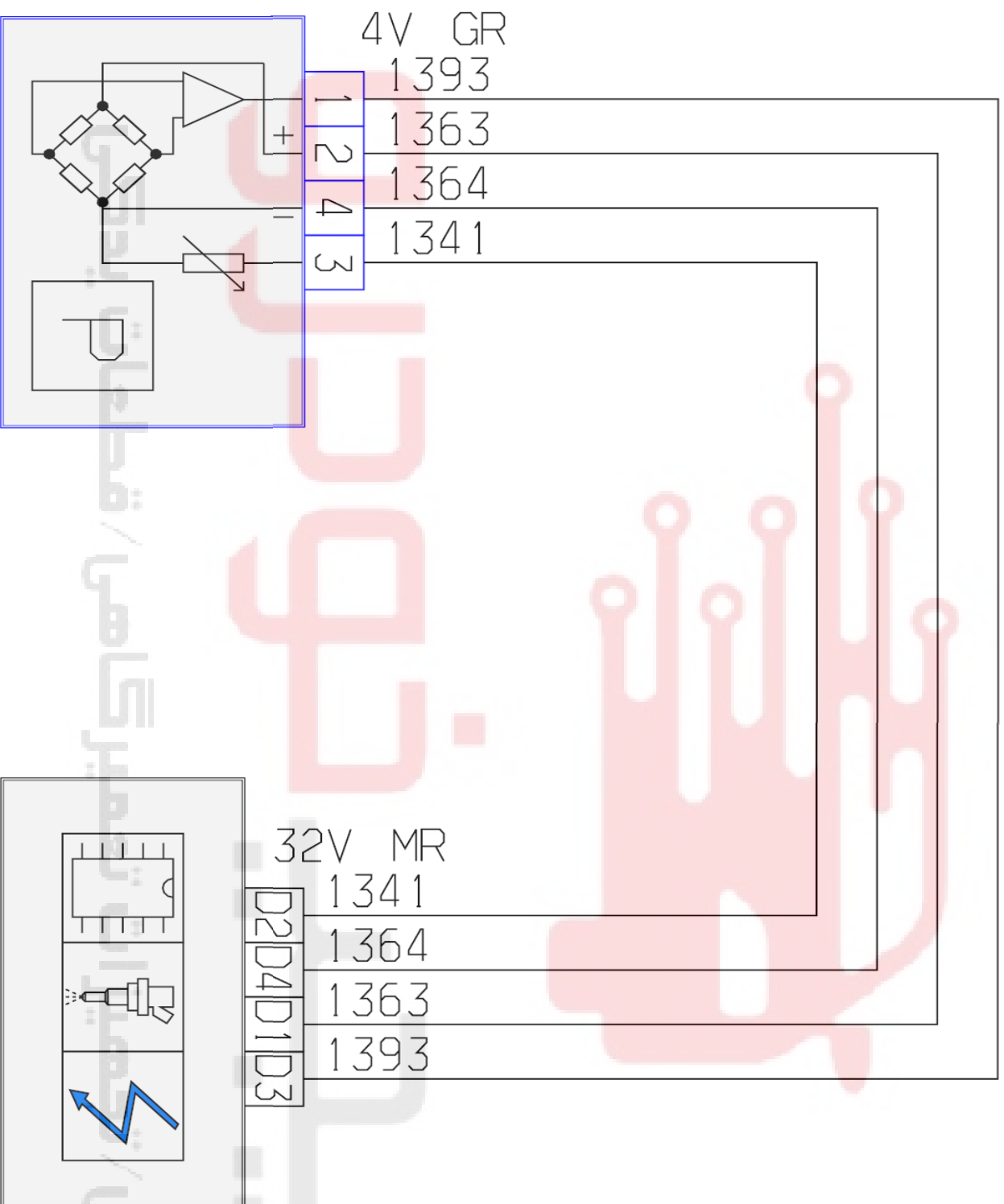

206 TU3A / J34P

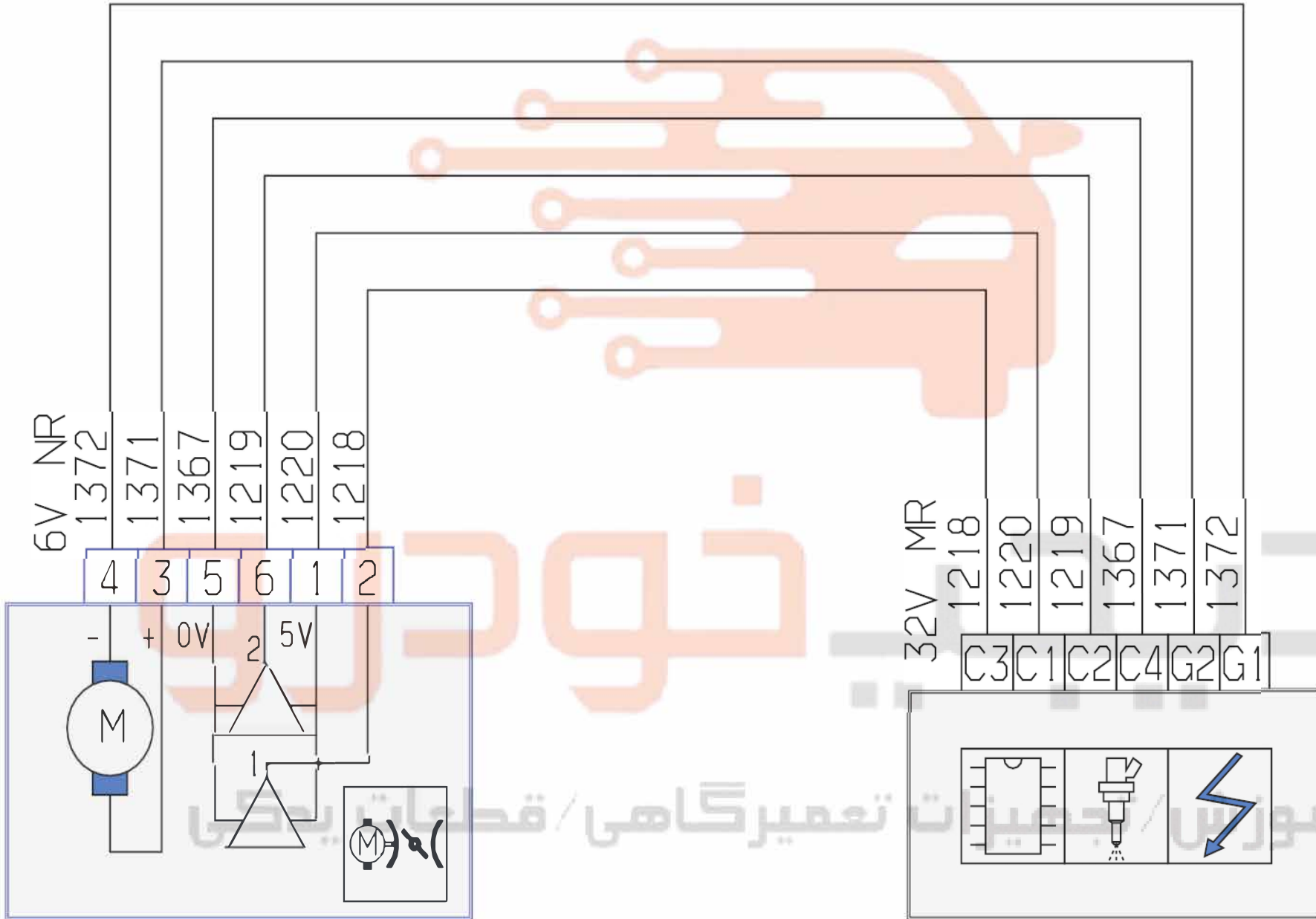

1262

1320

20 MOT

Engine

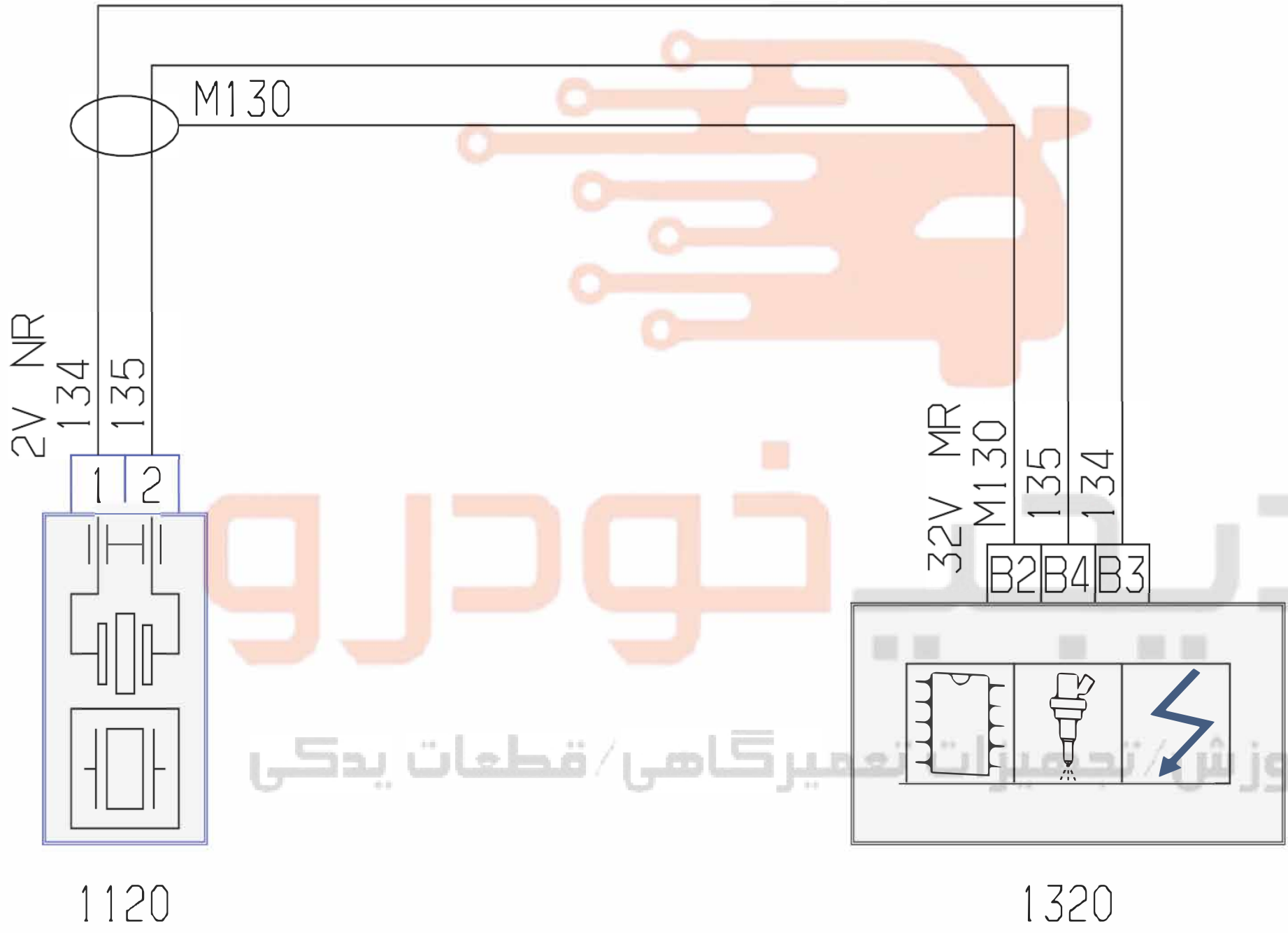

M130

2V NR

134

135

32V MR

M130

135

134

B2

B4

B3

1120

1320

آموزش / تعمیرات تعمیرگاهی / قطعات یدکی

20 MOT

Engineering Office

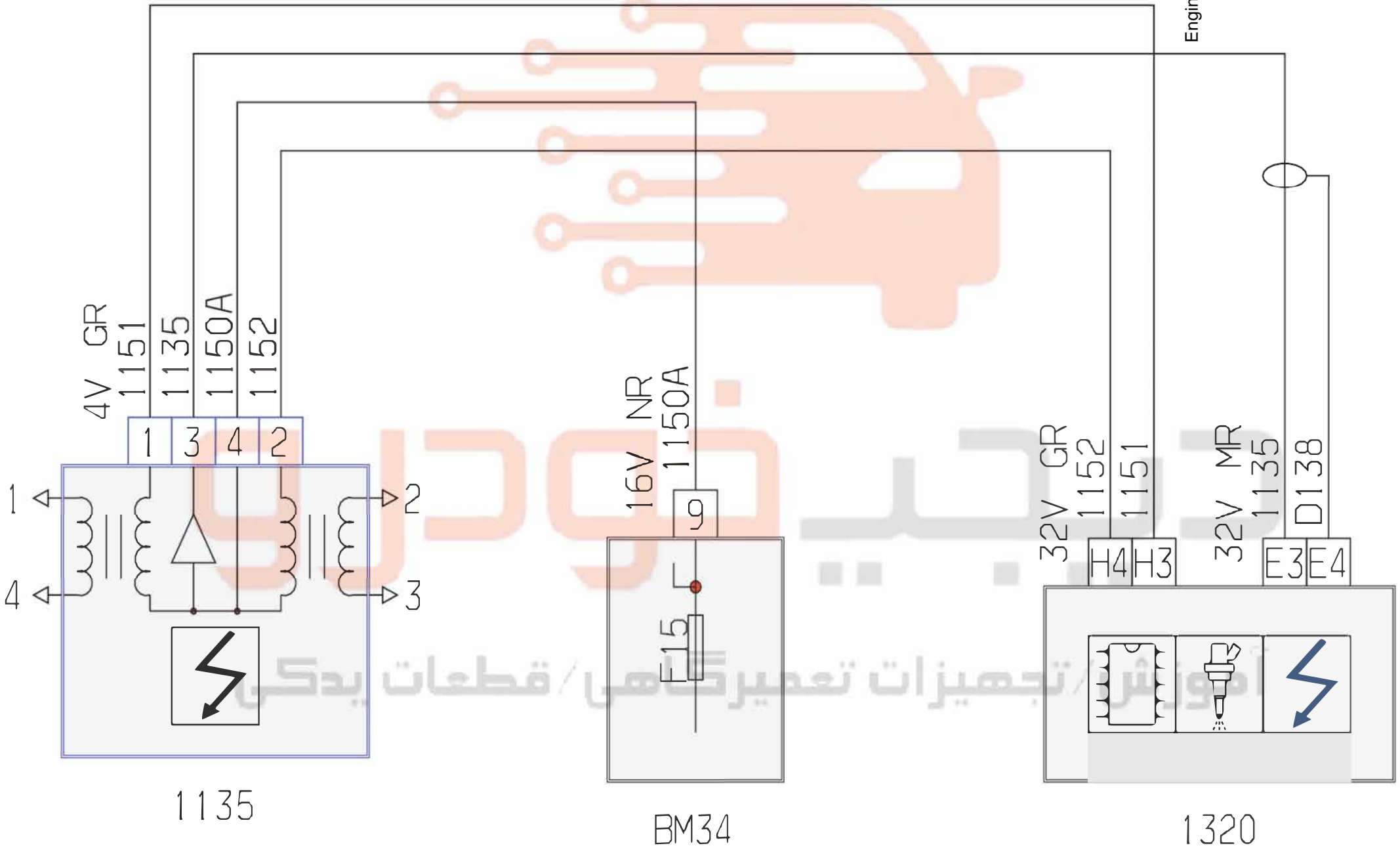

1135

BM34

1320

20 MOT

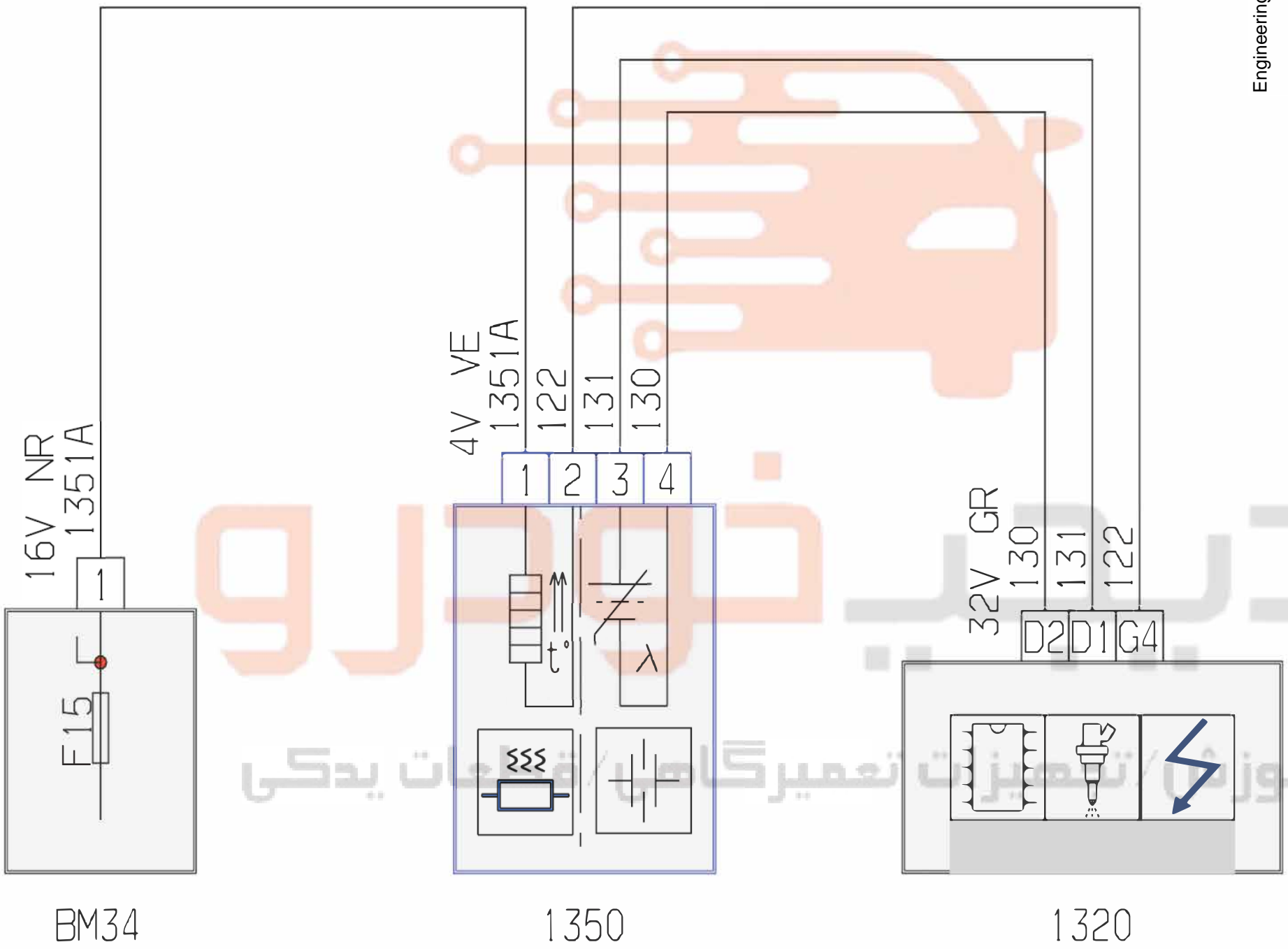

Engineering Office

BM34

1350

1320

20 MOT

Engineering Office

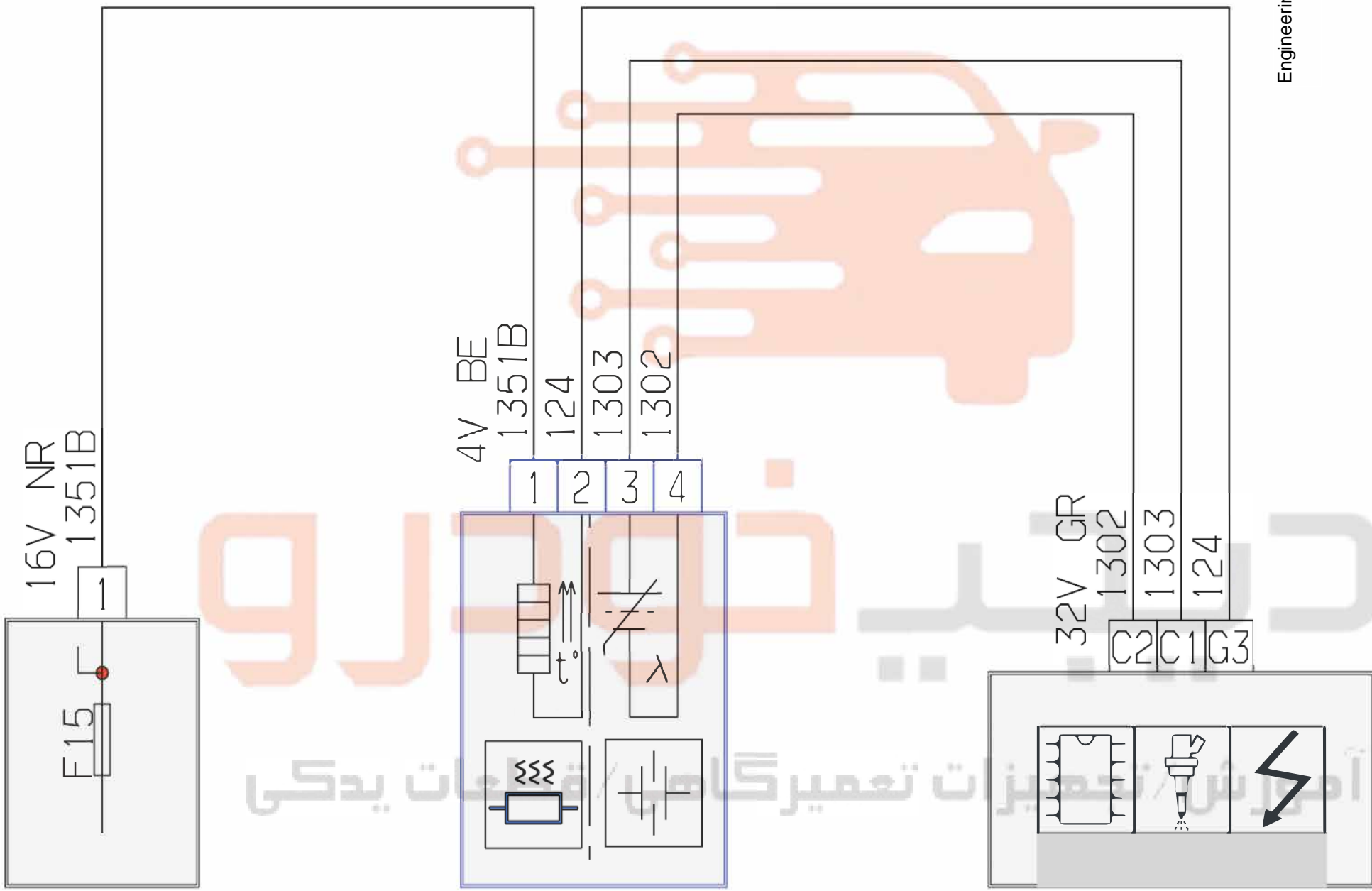

BM34

1351

1320

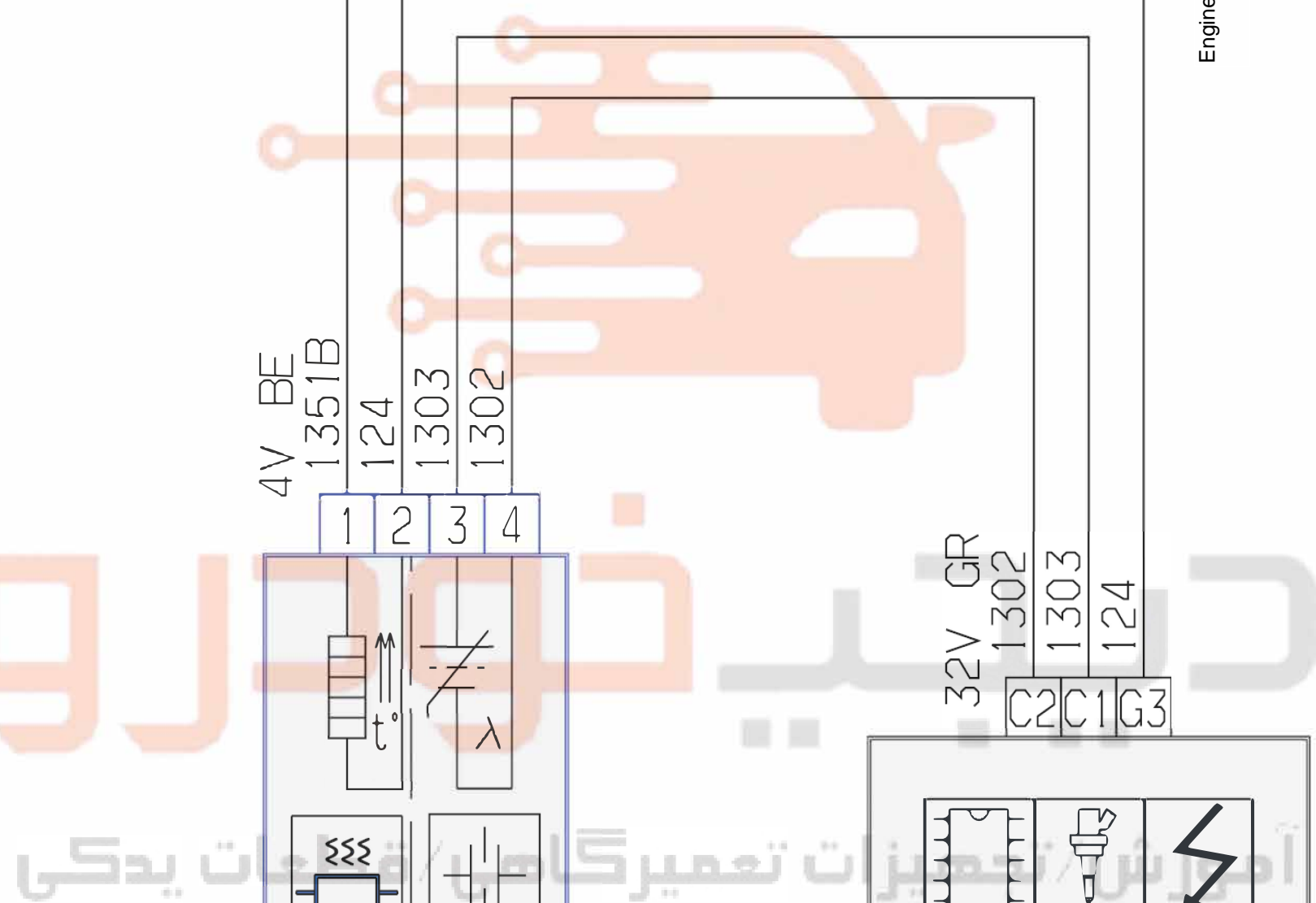

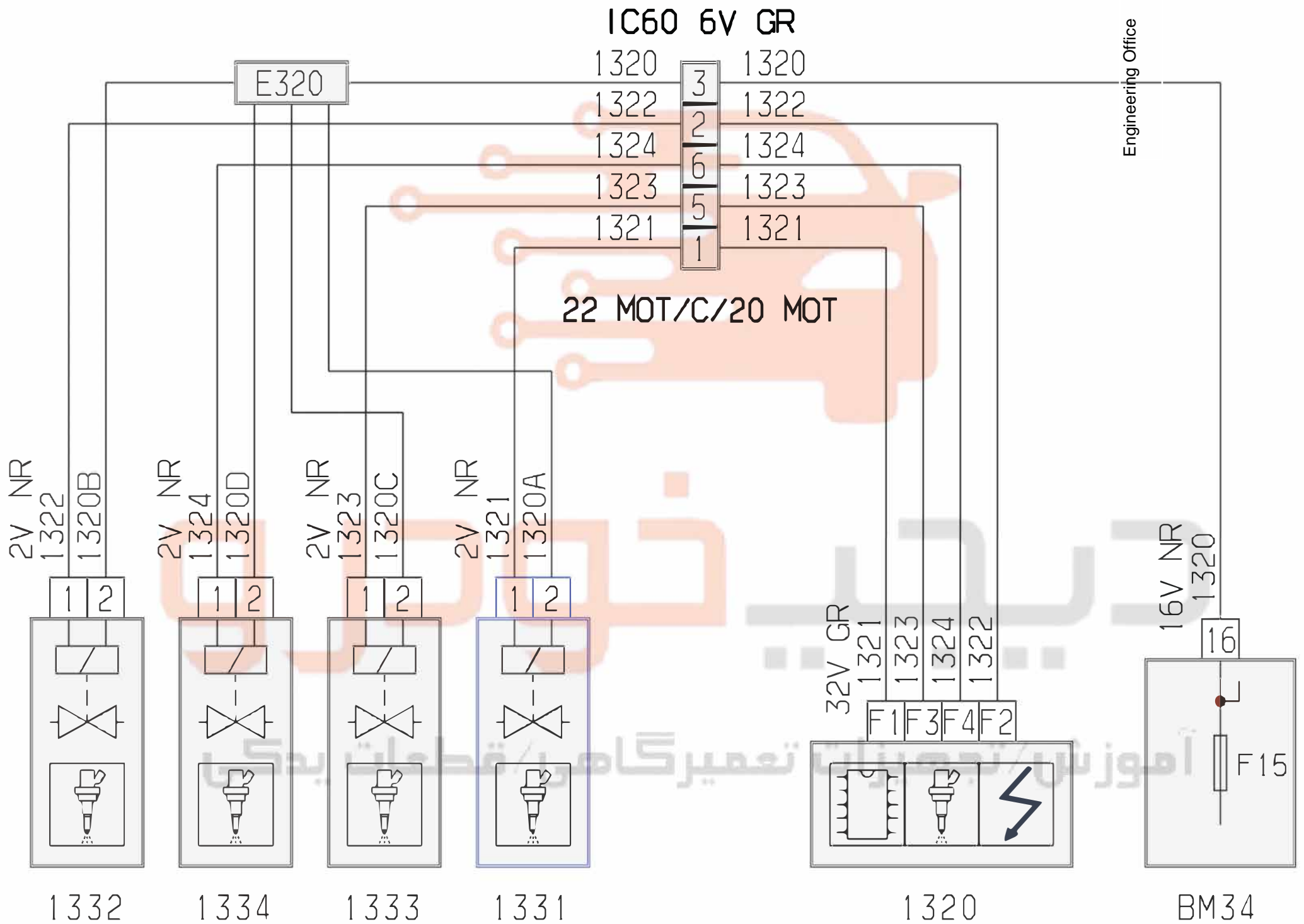

Engineering Office

10 PR

Engineering Office

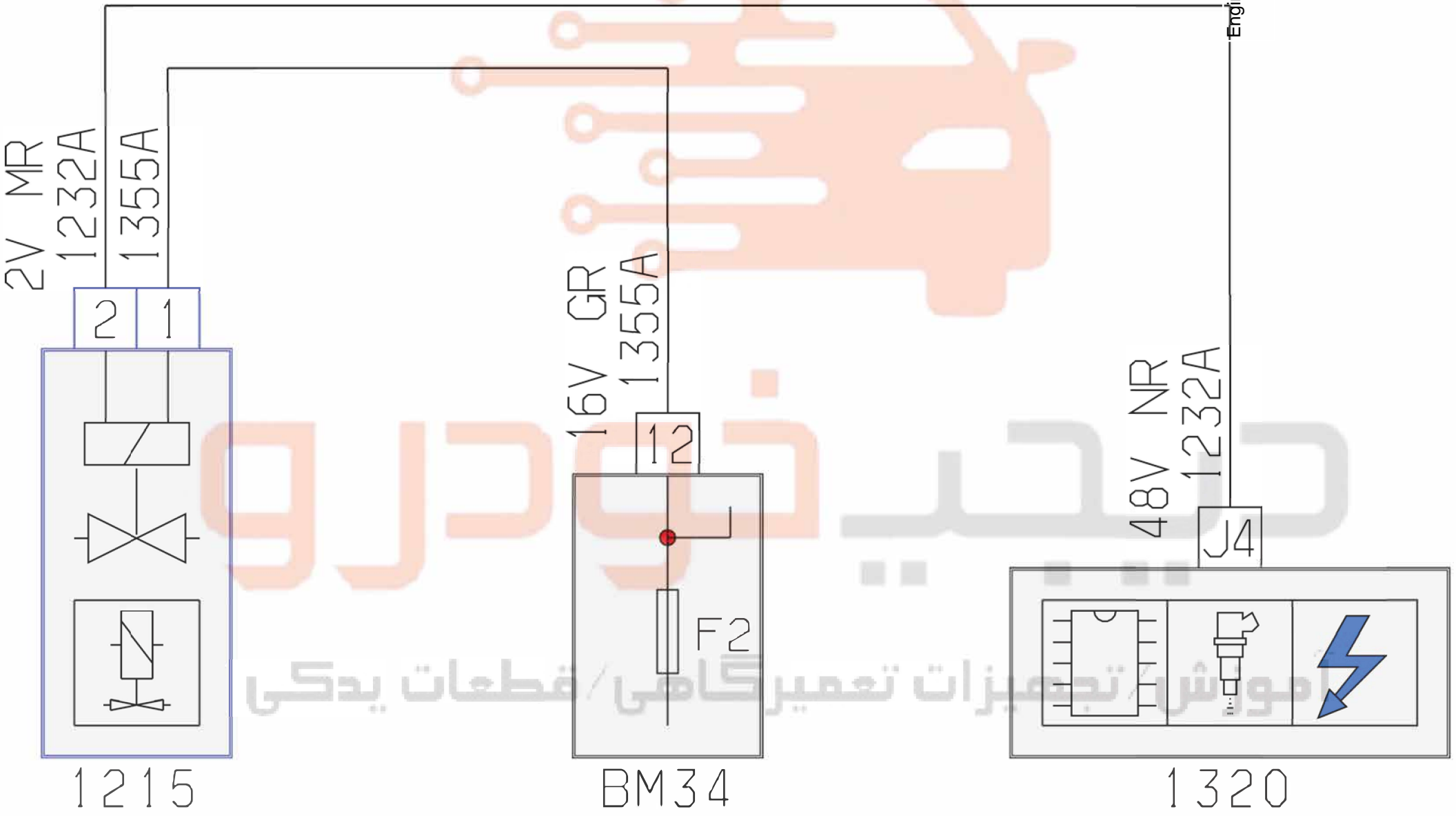

آموزش تعمیرات تجهیزات تعمیرگاهی / قطعات یدکی

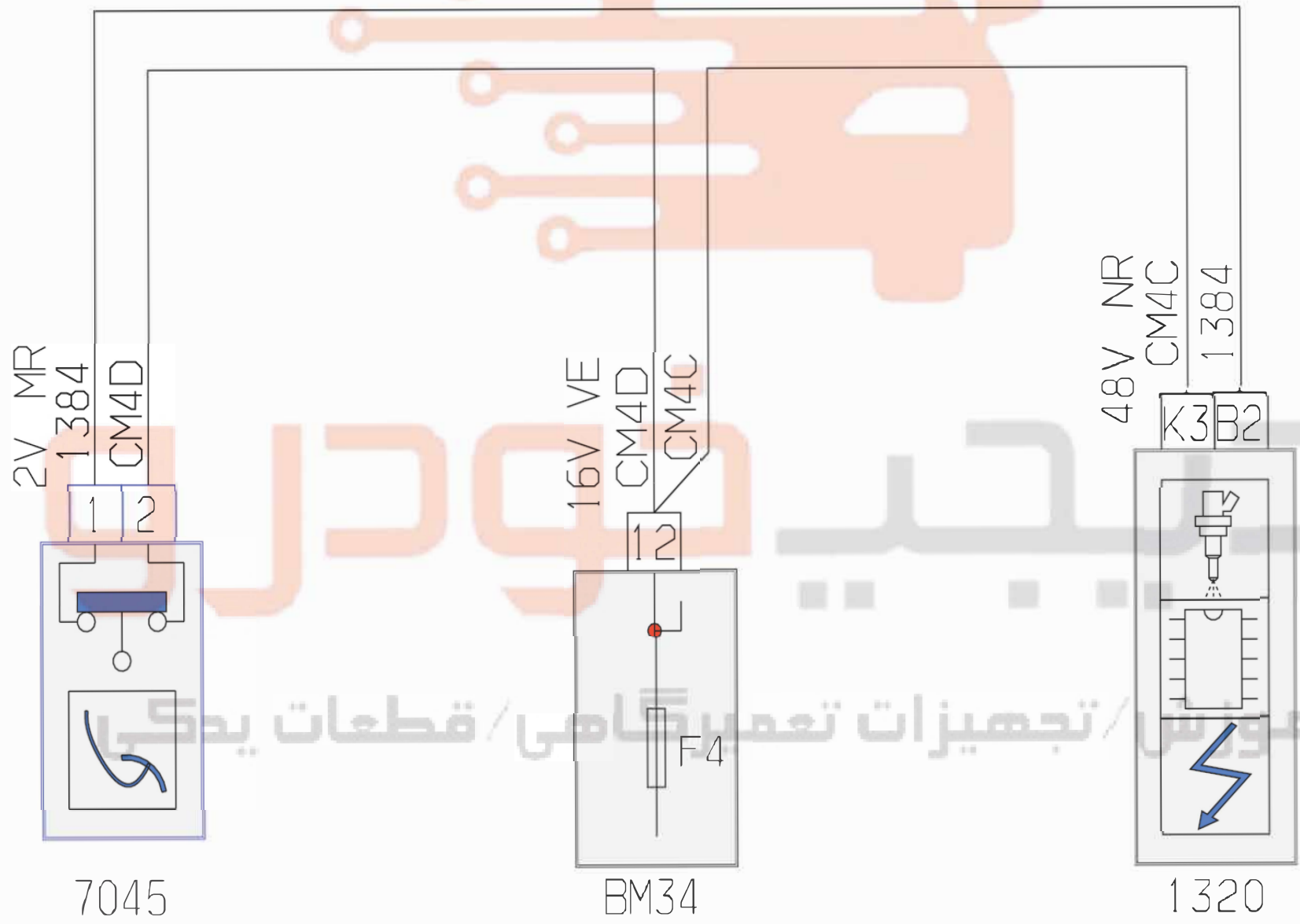

20 MOT

Engineering Office

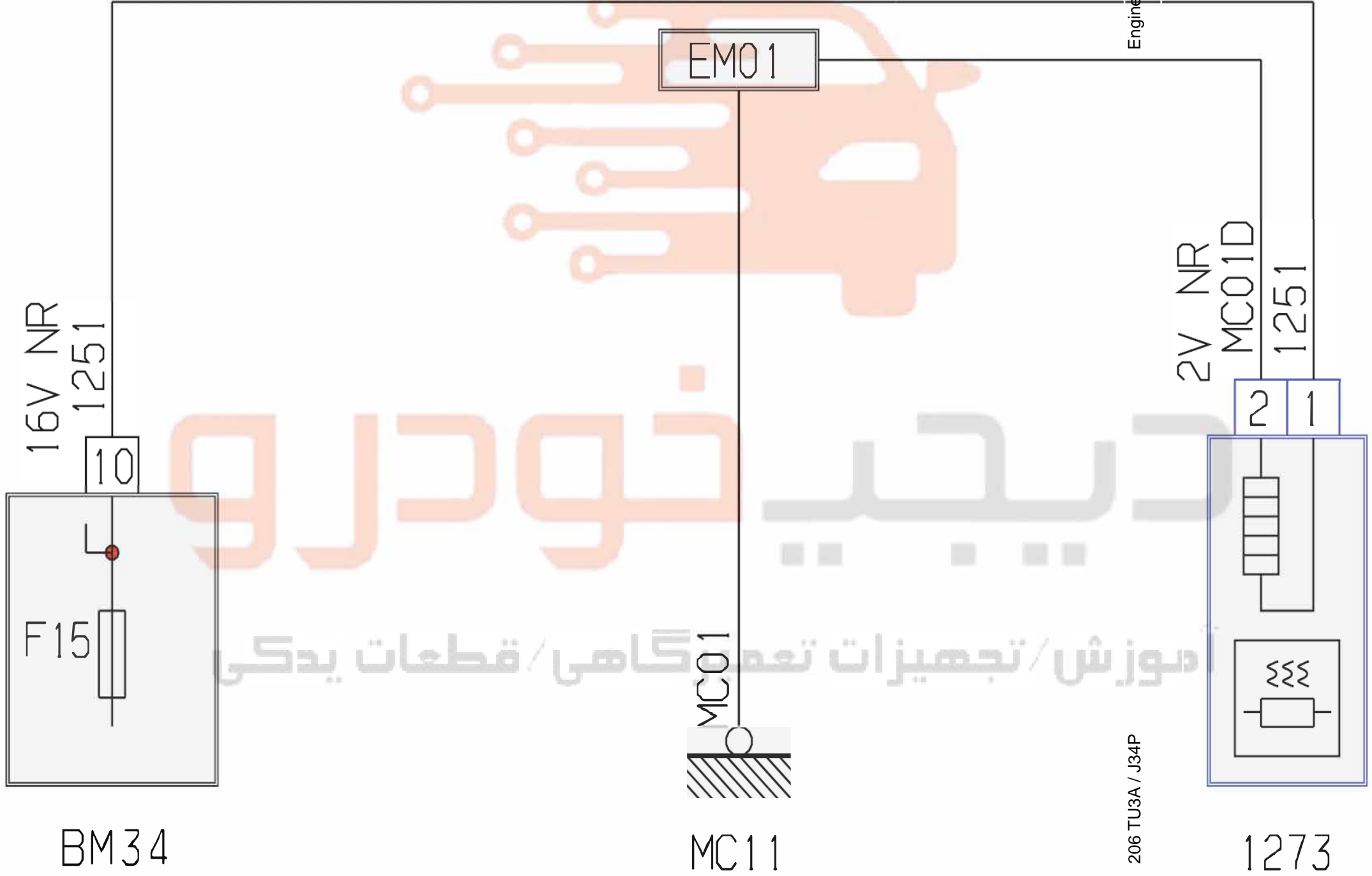

16V NR
1251

10

F15

BM34

EMO1

MC01

MC11

2V NR
1251

2

1

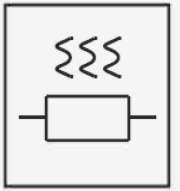

1273

206 TU3A / J34P

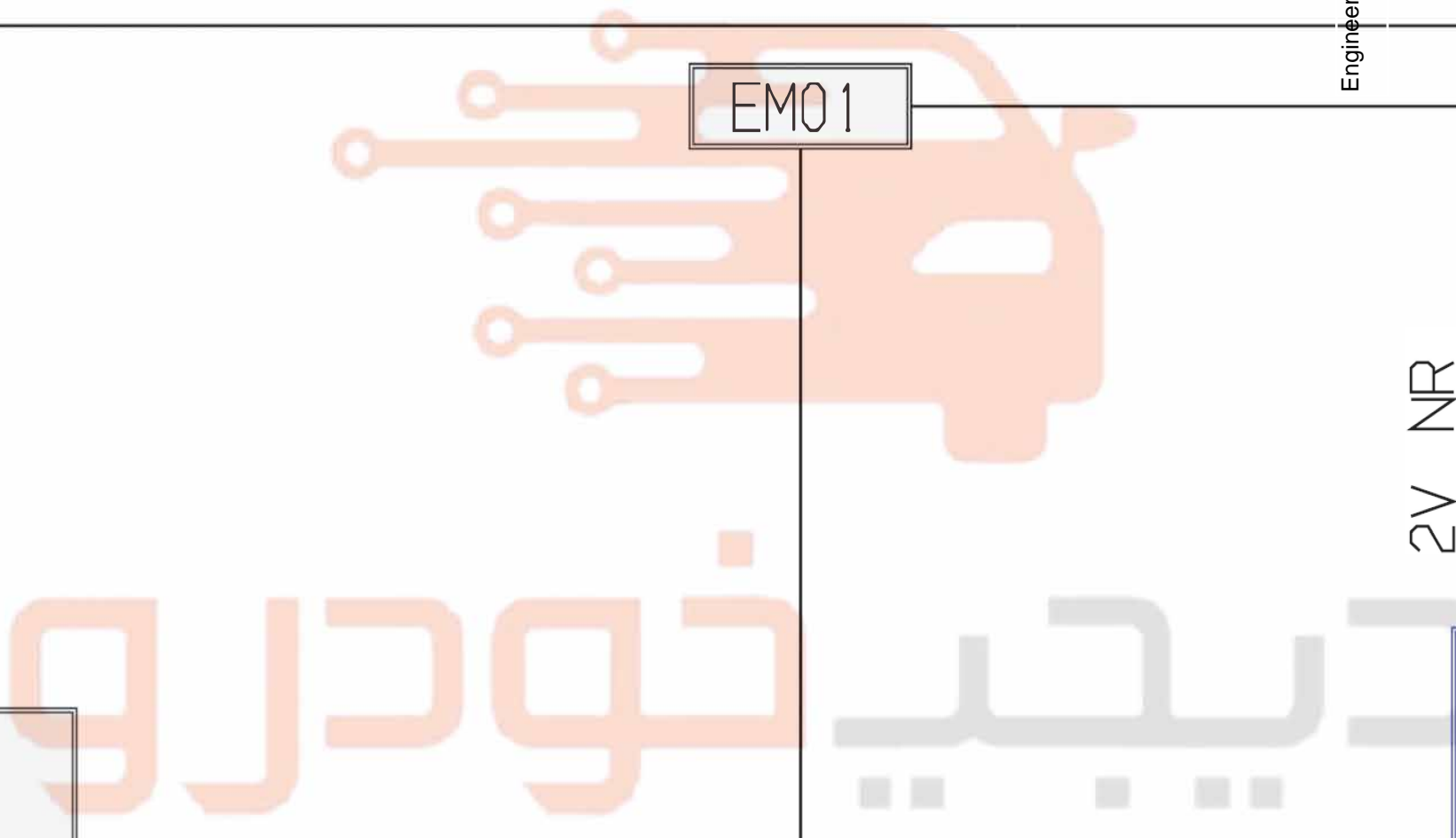

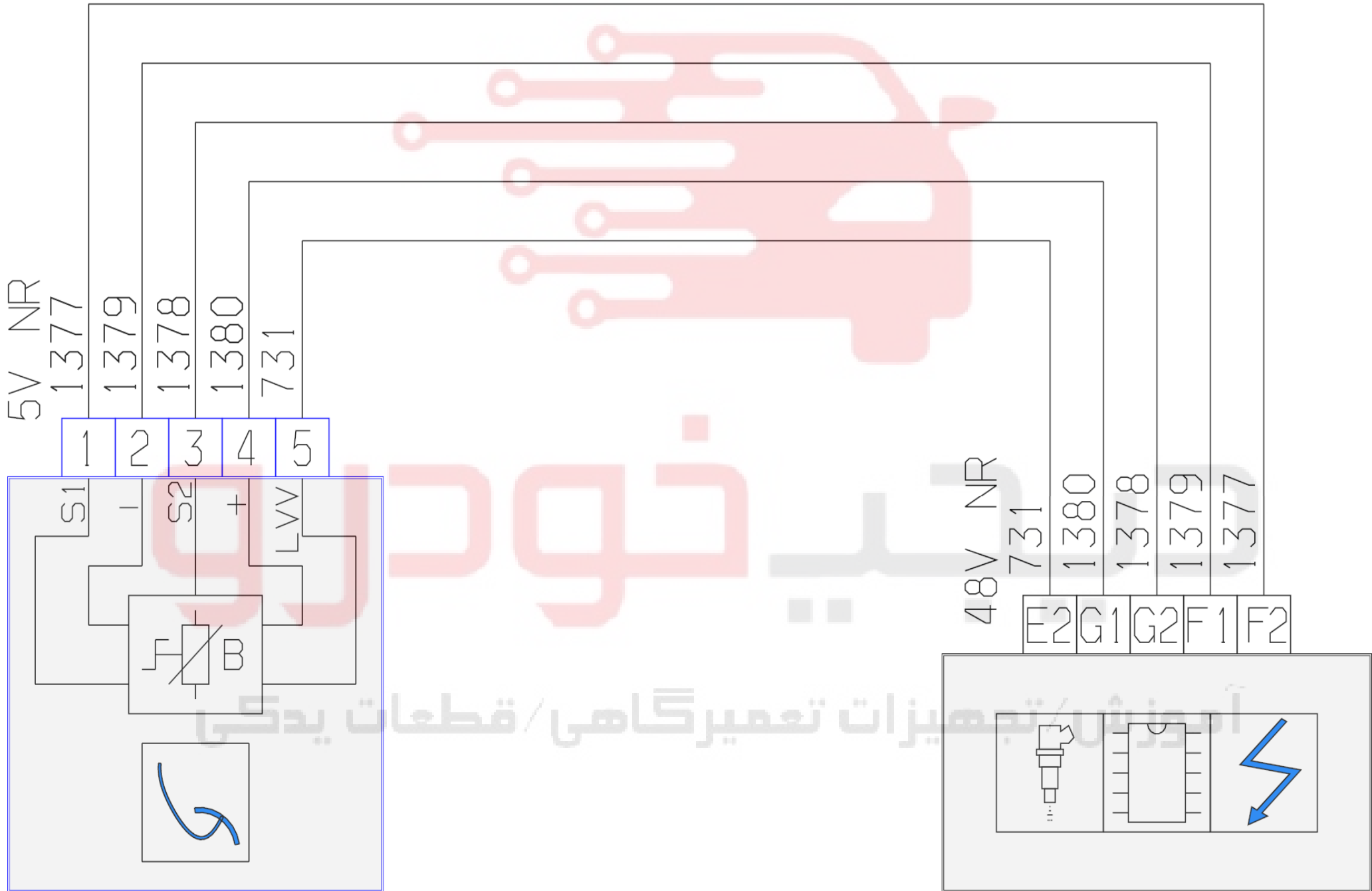

آموزش / تجهیزات تعمیرگاهی / قطعات یدکی

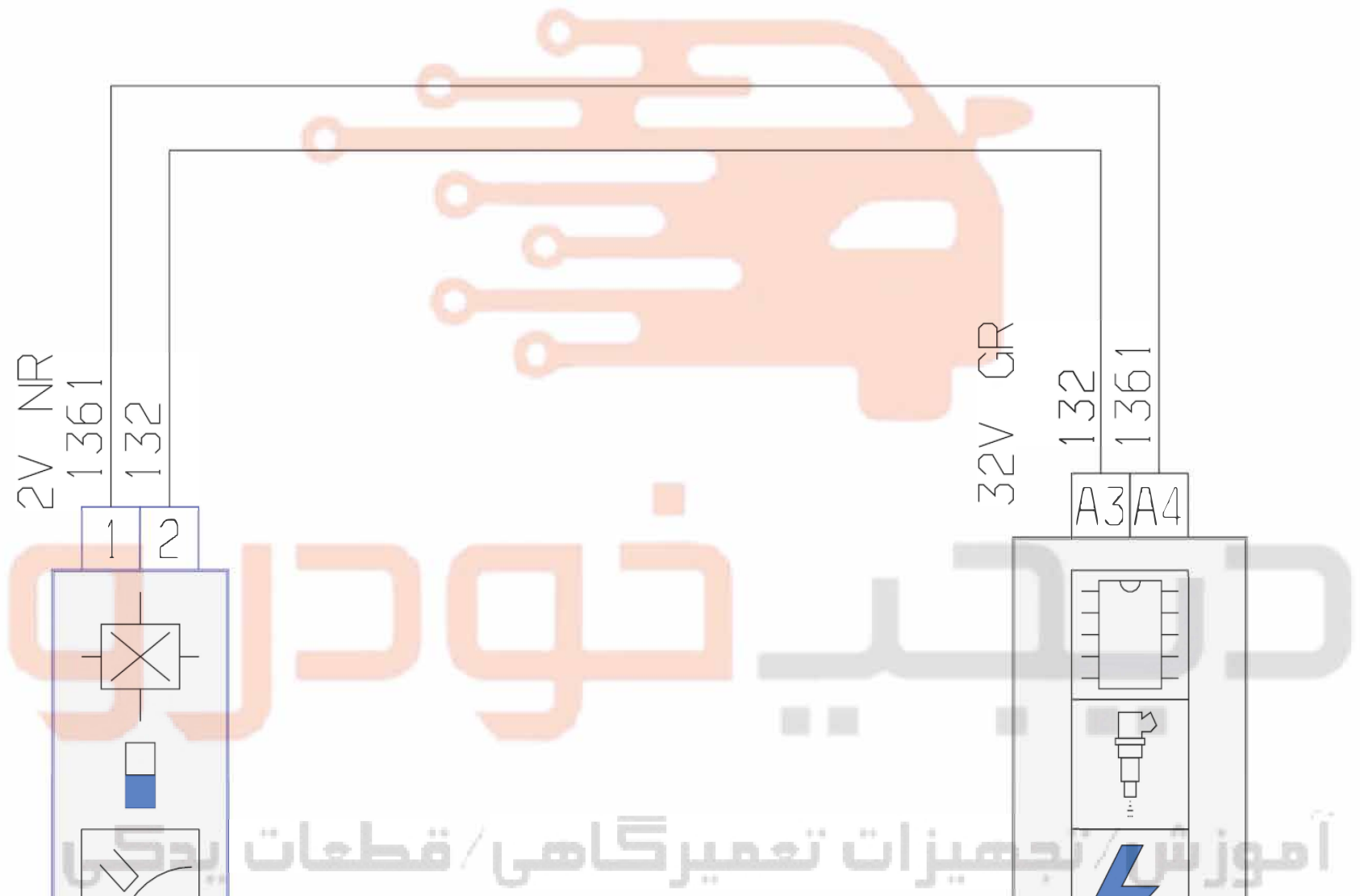
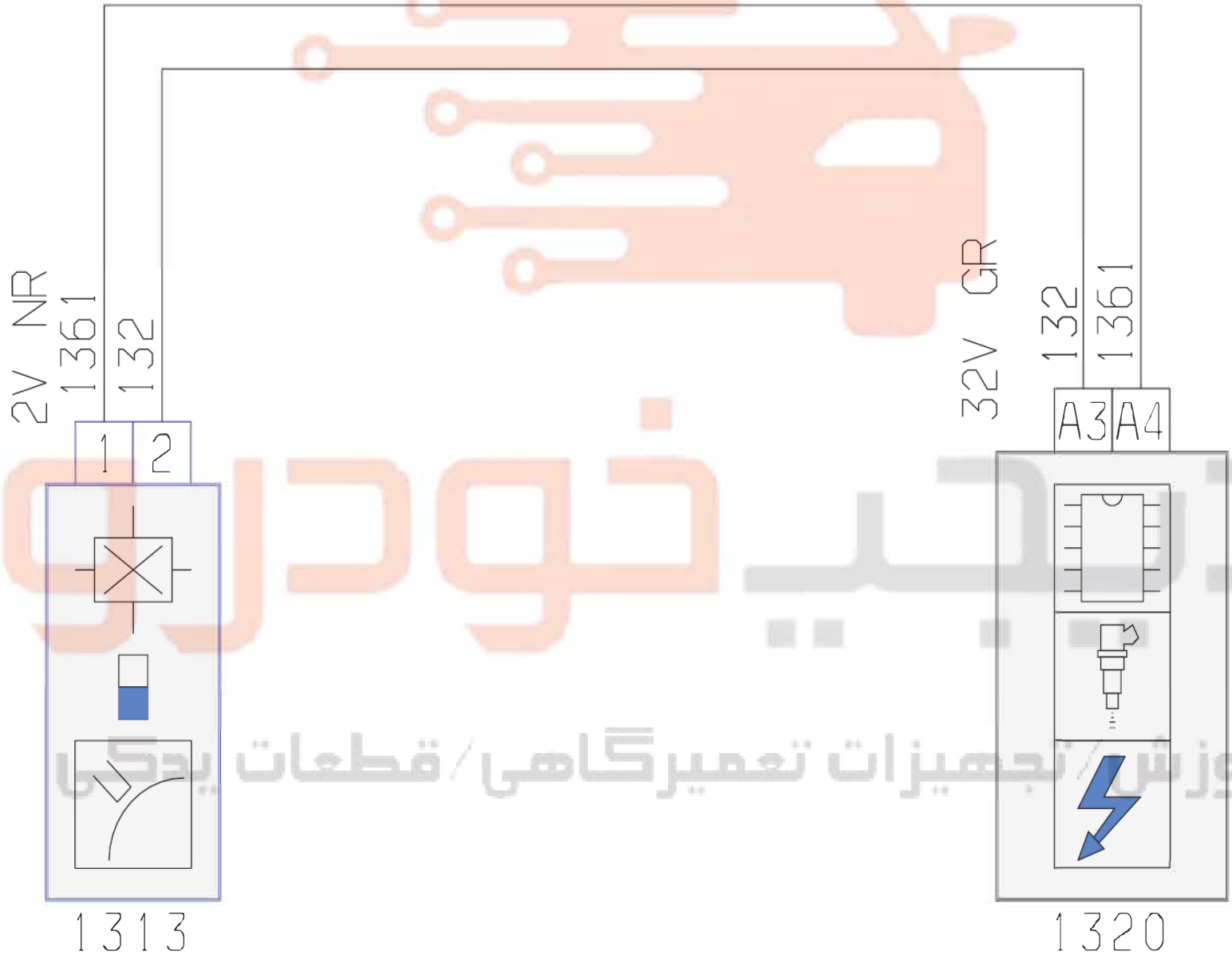

آموزش / تجهیزات تعمیرگاهی / قطعات یدکی